

**PS** PROFESSIONAL SPARES

# HOBART

Octobre 2017



**Sous table**



**Capot**



**Lave-batterie**



**Machine Avancement  
Automatique**



## **Sous table**

**Composants Electriques**

**Composants Eau**

**Composants Mécaniques**

**Composants électroniques**

**Joints**

**Accessoires**

**Interrupteurs, Boutons, Sélecteurs**

**383600**



**Sectionneur principal [KIT]**  
dim. 69x120x80 mm

00695530000      00-695530-000      695530

**400801**



**Sectionneur principal [KIT]**  
100A 220/690V; extension Ø 8,50xLtot 215 mm

00301773001      00-301773-001      3017731  
301773-1

**393006**



**Poussoir double O-I Ø 22 mm**  
dim. 30x50 mm; sans contacts

00-738650-001      00740522001      00-740522-001  
00740522-1      7386501      738650-1  
7405221

**362975**



**Interrupteur bipolaire 16A 250V - ROLD**

62208010      62-208010      E208010

**364239**



**Interrupteur bipolaire 16A 250V - ROLD instable**

139321455      139321-455      E226071

**410144**



**Poussoir vert Ø 22 mm**  
sans contacts auxiliaires

00887015022      00-887015-022      88701522  
887015-22

**402613**



**Capuchon bouton poussoir 23x24 mm**

00374331001      00-374331-001      3743311  
374331-1

**376424**



**Boutton 27x27xH35 mm**

00324266001      00-324266-001      3242661  
324266-1

**397964**



**Groupe contacts 250V 6(4)A**  
dim. 22,2x22,2x26 mm; faston 2,8x0,8 mm

00774793005      00-774793-005      7747935  
774793-5

**376423**



**Boutton Ø 21mm avec Lentille**

E227061

**Lampes et Carters de Lampe**

**340396**



**Voyant fluorescent Ø 9 mm 240V**  
L=55 mm - faston 6,3x0,8 mm

E216006

**Contacteurs et Relais**

**391087**



**Contacteur 100-K09KF10**  
3kW 3P; 230/240V 50/60Hz; 4kW 400V 50/60Hz; 3 cont. NO + 1 aux NO; dim. 53x45x54 mm

00-141440-001	00141440002	00-141440-002
00740520001	00-740520-001	1414401
141440-1	1414402	141440-2
740520-001		

**376074**



**Contacteur LC1K09 004U7**  
4kW 3P; 230/240V 50/60Hz 440V 4 cont. NO + 1 AUX NC; dim. 57x45x58 mm

00695521062	00-695521-062	00-775599-001
69552162	695521-62	775599001
775599-001	7755991	775599-1

**409676**



**Contacteur C25DNY125A**  
5,5kW 3P; 25A; 230V 50/60Hz 7,5kW 460V - bobina 110-120V 50/60Hz; dim. 60x82x95 mm

000877130851	00-087713-085-1	000877131081
00-087713-108-1	00-087713851	877131081
87713-108-1	87713851	87713-85-1

**409698**

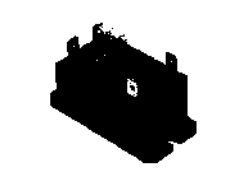

**Relais 277Vac 30A NO - 3A NC**  
bobine 120Vac

000877140461	00-087714-046-1	87714461
87714-46-1		

**409701**



**Relais 2P 120Vac**  
20A 400Vac; faston 6,3x0,8 mm

000877140421	00-087714-042-1	87714421
87714-42-1		

**351268**



**Relais 1 contacts 230VAC 50/60Hz 16A 250V**  
Faston 6.3x0.8 mm

00-371450-011	37145011	371450-11
E229030		

**336518**



**Relais 1 contacts 250V 50/60Hz 20A**  
Faston 6.3x0.8 mm

37145010	E229029
----------	---------

**364351**



**Relais 3 contacts 230V 50/60Hz 16A**  
Faston 6.3x0.8 mm

E229036	E229039	E229040
MRTFOC00144		

**Contacteurs et Relais**

**396914**



**Relais temporisé 3-300 sec. 220-240V  
50/60Hz  
dim. 80x22x78 mm**

00493530001      00-493530-001      4935301  
493530-1

**Microinterrupteurs**

**200227**



**Microinterrupteur à poussoir 10A 250V**

00-324195-000      324195      7352211

**363588**



**Microinterrupteur à poussoir avec levier  
5x28 mm**

13932141      139321-41

**389238**



**Microinterrupteur magnétique Ø  
5,6x25,5 mm  
câble L=120 mm**

01515276001      01-515276-001      015152761  
01-515276-1

**376214**



**Microinterrupteur magnétique Ø  
5,6x25,5 mm  
câble L=330 mm**

01240288001      01-240288-001      012402881  
01-240288-1

**384291**



**Microrupteur magnétique M8x0,75 L=42  
mm  
1 NO, 200Vdc/250Vac 1A 50W; câble L=310  
mm**

00-738942-000      00740173000      00-740173-000  
738942      740173

**435219**



**Microinterrupteur magnétique  
NO contact 250V 50VA 0,04A - passo 5**

00775491001      00-775491-001      7754911  
775491-1

**404634**



**Interrupteur à flotteur Ø 9,5x52 mm  
raccord 1/4"; câble L=130 mm**

0093654700001      00-936547-00001      00-936547-003  
00-936547-3      9365471      936547-1  
936547-3

**376164**



**Flotteur avec aimant Ø 45 mm H=33 mm  
dim: 60x48x33 mm**

00122674      00-122674      00122674000  
00-122674-000      122674

## Microinterrupteurs

384849



**Charniere pour flotteur**  
dim: 20x29x1.5 mm

00112467  
00-112467-000

00-112467  
112467

00112467000

376399



**Support aimant**

00883838001  
883838-1

00-883838-001

8838381

## Boites à bornes

439982



**Boite à bornes 6 pôles pour câble 6 mmq avec ponts installés**  
capacité 450V 40A Tmin-max -5 / +150°C;  
cosse 6,3x0,8 mm

00774055001  
00-774055-1-000  
774055-1

00-774055-001  
00774055-1000

00-774055-1  
7740551

## Pressostats

316549



**Pressostat 1 niveau 0÷30 mbar 0,5÷3,5 VDC**  
Pmax 200 mbar

7758661

376465



**Pressostat 1 niveau 0÷50 mbar 0,5÷3,5 VDC**  
IN 5Vdc; Pmax 200mbar; mod.  
AM900/AMS900/FP/FXN/FXS/GXS/FPS/GPS

00775866002  
775866-2

00-775866-002

7758662

398162



**Pressostat 1 niveau 0÷50 mbar 0,5÷3,5 VDC**  
Pmax 200 mbar

00775866202  
01-539157-501

00-775866-202  
775866202

01539157501  
775866-202

305962



**Pressostat 1 niveau 35/17 mbar**  
contact capacité 16A 250V; Tmax 85°C

139321521

E224004

376303



**Pressostat 1 niveau 35/20 mbar**  
dim: Ø 82xh44 mm; trou Ø 3.8 mm

00231981003  
231981-3

00-231981-003

2319813

339692



**Pressostat 1 niveau 55/35 mbar**  
capacité contacts 16A 250V; Tmax 85°C

13932123

139321-23

E224003

**Pressostats**

**451289**



**Pressostat 1 niveau 90/56 mbar**  
contact capacité 16A 250V; Tmax 85°C

E224005

**428812**



**Pressostat 1 niveau 110/70 mbar**  
contact capacité 16A 250V; Tmax 85°C

E224010

**312108**



**Pressostat 1 niveau 180/70 mbar**  
contact capacité 16A 250V; Tmax 85°C

E926049

**318119**



**Pressostat 1 niveau 105/125 mbar**  
contact capacité 16A 250V; Tmax 85°C

E224025

**376299**



**Pressostat 3 niveau 40/25-57/37-125/105 mbar**

00231981001  
231981-1

00-231981-001

2319811

**376301**



**Pressostat Ø 84mm 125/105 - 57/42 - 40/25mbar**

00378758004  
378758-4

00-378758-004

3787584

**Programmateurs**

**339910**



**Programmeur 40" 230V 50/60Hz**  
cavo L=250 mm; sans axe

E238052

**339690**



**Programmeur 3 cames**  
150" 230V 50/60Hz; sans axe, câble L=280 mm

E238053

**451552**



**Programmeur 4 cames P265**  
20min. + 1min.; 2 motor 110V 50/60Hz; mod. P265J04KB75

E238066



## Ventilateurs

**392366****Ventilateur 18W 24Vdc 0,75A**

01240261001 01-240261-001 012402611  
01-240261-1

**392364****Bayonet nut**

01240267001 01-240267-001 012402671  
01-240267-1

**382695****Raccord à T**

filetée 1/2" x 23mm, raccord Ø 22x80 mm; joint  
Ø 24x37x1,6 mm

00886606000 00-886606-000 886606

## Fusibles, Condensateurs, Filtres RFI

**311818**

**Condensateur de mise en phase 4µF  
450V 50/60Hz**  
Ø 30x71 mm; avec vis M8 et ecrou

00226568002 00-226568-002 2265682  
226568-2

**418004**

**Condensateur de mise en phase 5µF  
400V 50/60Hz**  
Ø 30x51 mm; avec vis M8

00226568009 00-226568-009 2265689  
226568-9

**332311**

**Condensateur de mise en phase 10 µF  
400/450V 50/60Hz**  
Ø 30x71 mm; ecrou M8

00226568010 00-226568-010 22656810  
226568-10

**344792**

**Condensateur de mise en phase 16µF  
450V 50/60Hz**  
Ø 30x71 mm; avec vis M8

00226568013 00-226568-013 00-232210-001  
22656813 226568-13 2322101  
232210-1 E206004

**390145**

**Condensateur de mise en phase 8µF  
400V 50/60Hz**  
Ø 30x82 mm; avec vis M8

00139321009 00-139321-009 00-226568-014  
00226568017 00-226568-017 00844956000  
00-844956-000 139321-9 22656814  
226568-14 844956

**315350****Fusible Ø 5x20 mm 0,50A 250V rapidee**

00785539027 00-785539-027 69561511  
695615-11 78553927 785539-27

**Fusibles, Condensateurs, Filtres RFI**

**435516**



Fusible Ø 5x20 mm 0,25A 250V retardé

00300099003      00-300099-003      300099-03  
3000993      300099-3

**312599**



Fusible Ø 5x20 mm 1A 250V retardé

00785539070      00-785539-070      6956152  
695615-2      78553970      785539-70

**397484**



Fusible Ø 5x20 mm 1,6A 250V retardé

00695615003      00-695615-003      00785539072  
00-785539-072      6956153      695615-3  
785539-072      78553972      785539-72

**451463**



Fusible Ø 5x20 mm 4A retardé

E228010

**320007**



Fusible Ø 5x20 mm 6,3A 250V retardé (10 pz)

00785539078      00-785539-078      78553978  
785539-78

**376162**



Fusible Ø 6,3x32 mm 0,8A 250V rapidee

00775570002      00-775570-002      7755702  
775570-2

**376163**



Fusible Ø 6,3x32 mm 6,3A 250V rapidee

00-152480-022      00775570001      00-775570-001  
15248022      152480-22      7755701  
775570-1

**393748**



Fusible 250mA 250V retardé

0091478200009      00-914782-00009      00914782009  
00-914782-009

**Pompes**

**450758**



Pompe de vidange 40W 220/240V 50Hz  
0,2A  
aspiration Ø 30 mm; sortie Ø 22 mm

E130123

**392282**



Pompe de vidange 65W 220-240V 50Hz  
0,6A

01240010001      01-240010-001      012400101  
01-240010-1

**Pompes**

**376279**



**Pompe de vidange 80W 220-240V 50Hz**  
 aspiration Ø 24 mm; sortie Ø 24 mm; faston P5

00-165653-001	00-699736-052	00-883527-001
00883993001	00-883993-001	1656531
165653-1	699736052	699736-052
8835271	883527-1	8839931
883993-1		

**376281**



**Pompe de vidange 80W 230-240V/50Hz**  
 aspiration Ø 24 mm; sortie Ø 24 mm

00883993012	00-883993-012	88399312
883993-12		

**376291**



**Pompe de lavage 1 phase 370W 230V 50Hz 2,3A**  
 aspiration Ø 45 mm; sortie Ø 40 mm; câble L=490 mm; C=10µF/450V

01240783001	01-240783-001	012407831
01-240783-1		

**376284**



**Pompe de lavage 1 phase 140W 220/240V 50Hz**  
 aspiration Ø 28 mm; sortie Ø 26 mm

01-240234-001	012402341	01-240234-1
01240234101	01-240234-101	

**382805**



**Pompe de lavage 1 phase 550W 220-240V 50Hz 3,8/3,48A**  
 câble L=630 mm

00-231936-001	00-775506-001	00895499000
00-895499-000	2319361	231936-1
7755061	775506-1	895499

**389384**



**Pompe de lavage 1 phase 588/660W 220/240V 50/60Hz**  
 turbine Ø 88 mm; C=8µF/400V

01515355001	01-515355-001	015153551
01-515355-1		

**392392**



**Pompe de lavage 1 phase 588/660W 220/240V 50/60Hz**  
 câble L=630 mm; C=8µF 400V

01-240091-001	012400911	01-240091-1
01240373001	01-240373-001	012403731
01-240373-1	01-240394-001	012403941
01-240394-1		

**323717**



**Pompe de lavage 1 phase 190W 230V 50Hz 0,9A SX**  
 C=5µF

E999134

**324356**



**Pompe de lavage 1 phase 450W 230V 50Hz 2,5A**  
 embout tuyau Ø 11 mm; câble L=220 mm; C=10µF

E130120

**316688**



**Pompe de lavage 1 phase 600W 230V 50/60Hz 3,8A**  
 aspiration Ø 50 mm; sortie Ø 50 mm; C=16µF

139321963 E130109

**Pompes**

**317746**



**Pompe de lavage 1 phase 850W 200/230V 3,8A**  
 aspiration Øext 50 mm; sortie Øext 48 mm;  
 C=16µF

E130126

**316693**



**Pompe de lavage 1 phase 1100W 230V 50/60Hz 3,8A**  
 aspiration Øext 60 mm; sortie Øext 50 mm;  
 C=16 µF

139321

13947

**389253**



**Pompe de rinçage 1 phase 140W 220-240V 50Hz 0,6A**  
 aspiration Ø 28 mm; sortie Ø 26 mm; câble  
 L=105 mm; câble L=130 mm

01515260001  
 01-515260-1

01-515260-001

015152601

**389251**



**Pompe de rinçage 1 phase 140W 220-240V 60Hz 0,6A**  
 aspiration Ø 28 mm; sortie Ø 26 mm; câble  
 L=105 mm; câble L=130 mm

01515260002  
 01-515260-2

01-515260-002

015152602

**376283**



**Pompe de rinçage 1 phase 250W 220-240V 1,2A 50Hz SX**  
 aspiration Ø 28 mm sortie Ø 26 mm; C=5µF  
 400V; câble avec faston L= 420 mm; câble  
 sans faston L= 600 mm

00324093001  
 00-324093-016  
 0032409316  
 324093-1  
 3240931V

00-324093-001  
 003240931  
 00-324093-16  
 32409316  
 324093-1V

00324093016  
 00-324093-1  
 3240931  
 324093-16

**613978**



**Pompe de rinçage 1 phase 220W 230V 1,1A 50 Hz**  
 SAPIN 5213; aspiration Ø 30 mm; sortie Ø 26  
 mm; 2800 rpm; C=5 µF 400V  
 (Pour les machines electrolux avec n° de  
 série.<60800000 voir KIT 0L1640)

E929167

**376282**



**Pompe de rinçage 1 phase 100W 220-240V 50Hz 0.46A**  
 sortie Ø 26 mm; C=4µF 400V

00-775465-001  
 7754651

00897929000  
 775465-1

00-897929-000  
 897929

**376276**



**Pompe de rinçage 1 phase 140W 220-240V 0,6A 50Hz - SX**  
 aspiration Ø 28 mm; sortie Ø 26 mm; C=4µF  
 400V; AMX, AUXXL, ECOMAX  
 402-452-502-602-612, FX-FP

00775854001  
 775854-1

00-775854-001

7758541

**376277**



**Pompe de rinçage 1 phase 270W 220/240V 1,3A 50Hz SX**  
 aspiration Ø 28 mm sortie Ø 26 mm; C=5µF  
 400V

00-324093-021  
 32409321V

32409321  
 324093-21V

324093-21

**404086**



**Couvercle pour pompe de lavage 3/4"**  
 pour pompe 456569 - 456571

E111023

**Pompes**

**392091**



**Couvercle pour pompe de lavage 392392 [KIT]**

01240393001    01-240393-001    012403931  
01-240393-1

**392440**



**Collier de serrage Ø 86,3x121,5x19 mm**

01240066001    01-240066-001    012400661  
01-240066-1

**392414**



**Anneau de maintien Ø 108x119x5,7 mm**

01240296001    01-240296-001    012402961  
01-240296-1

**382818**



**Couvercle de pompe [KIT]**

00895447000    00-895447-000    01-245113-001  
012451131    01-245113-1    895447

**453460**



**Turbine Ø 113 mm pour pompe 453459**

E41991

**403403**



**Turbine Ø 103 mm pour pompe 316692 - 316688**

E124031

**392275**



**Turbine + joint d'étanchéité [KIT] Ø 88 mm**

01240374001    01-240374-001    012403741  
01-240374-1

**392412**



**Turbine Ø 88 mm H=23 mm**

01240300001    01-240300-001    012403001  
01-240300-1

**376166**



**Turbine Ø 90 mm H=32,5 mm - sens de rotation droite**

00231876001    00-231876-001    2318761  
231876-1

**392089**



**Clapet Ø 44 mm [KIT]**

01-240046-001    012400461    01-240046-1  
01240395001    01-240395-001    012403951  
01-240395-1

**Pompes**

**450905**



**Soupape de ventilation L=142 mm**  
embout pour tuyau Ø 18 mm/Ø21 mm

E144003

**406768**



**Protection plastique**  
dim. 170x260xh0,3 mm

00867014001  
867014-1

00-867014-001

8670141

**389300**



**Support pompe**

01515154001  
01-515154-1

01-515154-001

015151541

**Résistances**

**376323**



**Résistance surchauffeur 1830W 254V**  
dim. 410x35,5 mm; bride 50x27 mm avec joint;  
faston 6,3x0,8 mm

00324646001  
324646-1

00-324646-001

3246461

**376327**



**Résistance surchauffeur 2440W 254V**  
dim. 410x35,5 mm; bride 50x27 mm avec joint;  
faston 6,3x0,8 mm

00324646002  
324646-2

00-324646-002

3246462

**376334**



**Résistance surchauffeur 3000W 230V**  
dim. 410x35,5 mm; bride 50x27 mm avec joint;  
faston 6,3x0,8 mm

00324646004  
324646-4

00-324646-004

3246464

**376332**



**Résistance surchauffeur 3050W 254V**  
dim. 410x35,5 mm; bride 50x27 mm avec joint;  
faston 6,3x0,8 mm

00-228579-001  
00-324646-003  
2285792  
324646-3

00-228579-002  
2285791  
228579-2

00324646003  
228579-1  
3246463

**398484**



**Résistance surchauffeur 2500W 254V**  
dim. 350x85 mm; avec sonde; faston 6.3x0.8  
mm; F5.3x0.8 mm; raccord M5.5 mm CH 10

00775464006  
775464-6

00-775464-006

7754646

**376337**



**Résistance surchauffeur 3000W 240V**  
dim. 350x80mm; avec sonde; faston 6.3x0.8  
mm

00775464002  
775464-2

00-775464-002

7754642

**Résistances**

**376339**



**Résistance surchauffeur 4880W 254V**  
L=420 mm

00324637002	00-324637-002	00324637102
00-324637-102	324637-02	324637102
324637-102	3246372	324637-2

**376344**



**Résistance surchauffeur 6000W 240V**  
dim. 82x350 mm; faston 6.3x0.8 mm

00775464001	00-775464-001	7754641
775464-1		

**319309**



**Resistance surchauffeur 2600W 230V**  
L=270 mm; bride 70x18 mm

E230100

**451495**



**Resistance surchauffeur 2700/3200W 220/240V**  
L=315 mm; bride 70x25,5 mm; connexions M4

E230088

**340183**



**Résistance surchauffeur 2400W 240V**  
L=200 mm; triangulaire bride 72x72 mm

00-139321-246	00-371450-013	139221-246
139321246	139321-246	37145013
371450-13		

**316875**



**Résistance surchauffeur 6000W 240V**  
L=325 mm; triangulaire bride; avec decoupé pour bulbe Øint 5 mm, avec o-ring

01240761001	01-240761-001	01240761002
01-240761-002	012407611	01-240761-1

**389254**



**Résistance surchauffeur 7260W 250V**  
L=350 mm; triangulaire bride 83,5x79 mm; Øint 49,50; con guaina portabulbo L=225 mm; Faston 6,3

01515258001	01-515258-001	015152581
01-515258-1		

**378617**



**Résistance surchauffeur 7260W 250V**  
L=380 mm; triangulaire bride; avec decoupé pour bulbe Ø 5 mm, avec O-ring

01-240135-001	01240135002	01-240135-002
012401351	01-240135-1	012401352
01-240135-2		

**315710**



**Résistance surchauffeur 2600W 230V**  
L=265 mm; triangulaire bride; avec O-ring en découpe pour bulbe L=175 mm

E230113

**316645**



**Résistance surchauffeur 3000W 230V**  
L=330 mm; triangulaire bride; avec découpe pour bulbe Øint 7,5 mm

E230116

## Résistances

317921



**Résistance surchauffeur 4500W 230V**

L=335 mm; triangulaire bride 72x72 - raccord M4 avec découpe pour bulbe Ø 5,5 mm

00-371450-012

E230034

E230081

318116



**Résistance surchauffeur 4900W 230/400V**

L=233 mm; triangulaire bride 72x72 - connexion M4 avec découpe pour bulbe Øint 7 mm

E230111

316839



**Résistance surchauffeur 5500/6543W 220/380V [KIT]**

L=355 mm; triangulaire bride 72x72 - connexion M4 avec découpe pour bulbe Øint 7x175 mm

E230083

E230083C

323472



**Résistance surchauffeur 8000W 230V [KIT]**

L=365 mm; triangulaire bride H= 83 mm Øint.49 mm; avec découpe pour bulbe; connexion M4 joint torique

E230020

E230095

319418



**Résistance surchauffeur 9500W 230V**

L=335 mm; triangulaire bride 83,5x78,8 mm - connexion M4 avec découpe pour bulbe Øint 7,5 mm

E80398

389320



**Résistance cuve 975W 250V [Kit]**

L=168 mm

01-240247-001

012402471

01515292001

01-515292-001

015152921

01-515292-1

01515292101

01-515292-101

398242



**Résistance cuve 3000W 240V**

dim. 210x120 mm; bride 50,3x26,70 mm; F6,3

00775853001

00-775853-001

7758531

775853-1

376328



**Résistance cuve 2000W 240V**

dim. 315x33 mm; bride 50x26,5 mm; faston 6,3 mm

01240766001

01-240766-001

012407661

01-240766-1

01240766101

01-240766-101

451501



**Résistance cuve 600W 230V**

L=160 mm; bride 50x26,5 mm; faston 6,3x0,8 mm

E230098

451504



**Résistance cuve 1600W 230V**

L=305 mm; bride 50x27 mm; faston 6,3x0,8 mm

E230102



## Résistances

**339697**



**Résistance cuve 2050/2450W 220/240V**  
dim. 260x125 mm; raccord M4; distance de fixation 70 mm; fileté M10x1 mm

00-139321203  
00-371450-205  
371450205

00-139321-203  
139321203  
371450-205

00371450205  
139321-203

**317002**



**Résistance cuve 2750/3250W 220/240V**  
dim. 380x110 mm; raccord M10; distance de fixation 75 mm

E230086

**453748**



**Joint de résistance**  
dim. 65x20,5x6 mm

E437048

**385175**



**Joint 201x136x2 mm**

00170309000

00-170309-000

170309

**389261**



**Couverture**  
dim. 7,5x6x2,5 mm

01515113001  
01-515113-1

01-515113-001

015151131

## Transformateurs

**390229**



**Transformateur 400W 50/60Hz**  
dim. 112x126x107 mm; PRI- 400-415-440V - SEC- 220/230V

00226211015  
226211-15

00-226211-015

22621115

**397529**



**Transformateur 440-200/220-240 630 VA**

00695543001  
6955431

00-695543-001  
695543-1

695543-001

## Câbles

**382797**



**Boîte de connexion [KIT]**  
dim. 90x90x35 mm

00-229513-002  
2295132

00896967000  
229513-2

00-896967-000  
896967

**376298**



**Passe-fils à vis M32 - câble Ø 21 mm**

00695661005  
695661-5

00-695661-005

6956615

## Câbles

385626



Passe-fils Ø 12,5x20,5x7 mm

00064824

00-064824

64824

376310



Pass-fil Ø 29x41 mm

00886756003  
886756-3

00-886756-003

8867563

## Thermostats

387856



Thermostat à contact de sécurité

dim. 51x38x25 mm; câble L=260 mm; sonde  
L=500 mm

00271123

00-271123

271123

451532



Thermostat à contact Klixon 80°C

E236048

318112



Thermostat à contact 95°C 1P

E236047

E926189

435232

Thermostat à contact 110°C  
à réarmement manuel; 16A 250V00371450017  
371450-1700-371450-017  
E236039

37145017

339691



Thermostat d'utilisation 1P 53°C

capillaire revêtu L=600 mm; bulbe Ø 9,5x16,5  
mm; presse étoupe M14; 16A 250V

E236042

400373



Thermostat d'utilisation 1P 86+266°F

capillaire L=1200 mm; bulbe Ø 13x130 mm;  
presse étoupe M17002946810312  
294681-31-2

00-294681-031-2

294681312

317003



Thermostat de sécurité 1P 83°C

capillaire L=3150 mm; bulbe Ø 6x95 mm

00139321019  
13932119  
139321-39800-139321-019  
139321-19  
E23604300-139321-398  
139321398

376448



Thermostat de sécurité 125°C 1P 16A

capillaire revêtu L=1200 mm; bulbe Ø 4x130  
mm00227879000  
22787900-227879-000  
304239

00-304239-000

## Thermostats

387713



Presse-étoupe M12x1 [KIT]

00227024000

00-227024-000

227024

---

## Groupe de lavage

**376045**

**Bras de lavage/rinçage L=395 mm [KIT]**  
Mod GC 11 - GC 31

00775762001 00-775762-001 7757621  
775762-1

**376046**

**Bras de lavage inferieur L=390 mm**  
7 trou - ECOMAX 402, GC/GCP

01294032001 01-294032-001 012940321  
01-294032-1

**318954**

**Bras de lavage L=510 mm**  
moyeu Ø 17 mm - ECOMAX 502, AM10 / AM11  
/ AM141, FX/GX & FP/GP

01240050001 01-240050-001 012400501  
01-240050-1

**389263**

**Bras de lavage L=510 mm**  
PROFI FX-FXL-FXL-GX / PREMAX FP-GP

01515111001 01-515111-001 015151111  
01-515111-1

**376048**

**Bras de lavage L=512 mm**  
AM700, AM900 / AMS900, ECOMAX 600

00-324039-000 00-324444-000 00-324444-001  
00883472001 00-883472-001 324039  
324444 3244441 324444-1  
8834721 883472-1

**376053**

**Bras de rinçage L=395 mm**  
ECOMAX 402, GC/GCP

01294029001 01-294029-001 012940291  
01-294029-1

**376055**

**Bras de rinçage L=515 mm**  
AM10 / AM11 / AM141, AMX - AMXX / AUXX -  
AUP, ECOMAX 502, FX/GX & FP/GP, UXT /  
UPT

01-240084-003 012400843 01-240084-3  
01240096003 01-240096-003 012400963  
01-240096-3

**388475**

**Bras de rinçage L=520 mm avec Clip-in**  
PROFI AMXXL / PREMAX AUPL, PROFI AMX  
PROFI AMXX / PROFI AM900 / PREMAX AUP,  
PROFI FX-FXL-FXL-GX / PREMAX FP-GP

01515843001 01-515843-001 01539620001  
01-539620-001

**376056**

**Bras de rinçage L=520 mm**  
raccord M1/4" - AM900 / AMS900, AMX900,  
AMXXT Serie / AUXXT Serie, FX/GX SERIE

00324052000 00-324052-000 00-324445-000  
01-240084-002 012400842 01-240084-2  
01240096002 01-240096-002 012400962  
01-240096-2 324052 324445

**321464**

**Bras de rinçage droite L=110 mm**  
2 injecteur - ECOMAX 400, GE400, H400

E106036

**Groupe de lavage**

**339981**



Moyeu pour jet

13932135

E129039

**419146**



Moyeu pour jet

E115075

**459789**



Axe support jet Ø 18 mm - L=65 mm

01539034001

01-539034-001

015390341

**376474**



Axe support jet Ø 17 mm - L=60 mm

01240097001  
01-240097-1

01-240097-001

012400971

**376269**



Axe support jet Ø 16 mm - L=60 mm

00324040000

00-324040-000

324040

**389292**



Axe support jet Ø 18 mm - L=57 mm

01515171001  
01-515171-1

01-515171-001

015151711

**376405**



Support bras lavage supérieur

01-240013-001  
01294038001  
01-294038-1

012400131  
01-294038-001

01-240013-1  
012940381

**392114**



Support bras lavage inférieur 1" 1/2

01240641001  
01-240641-1

01-240641-001

012406411

**434446**



Support  
Øext. 38/ext. 59 mm H=70 mm

E115110

**315724**



Support Htot=126.5 mm

E115076

**Groupe de lavage**

**389391**



**Support bras de rinçage [Kit]**

01515333001      01-515333-001      015153331  
01-515333-1

**315727**



**Support bras lavage supérieur**

E111030

**419135**



**Support bras lavage supérieur**  
Ø 11,5 mm; Ø 31,7 mm

E115074

**450791**



**Support bras lavage Øint. 102/est. 140 mm**  
tuyau; 1 x Øest. 50 mm, 1 x Øest. 60 mm

E136020

**455355**



**Support bras de lavage supérieur L=310 mm**

E80177

**392280**



**Tuyau de branchement jets**  
dim. 600x340 mm

01240015001      01-240015-001      012400151  
01-240015-1      01-515160-001      015151601  
01-515160-1

**435956**



**Tuyau de branchement jets**  
H=690 mm

115113

E115113

**392680**



**Bouchon jet de rinçage Ø 23,5x28xH28 mm**

01245080001      01-245080-001      012450801  
01-245080-1

**318191**



**Bouchon [4 pcs]**

00-324172-000      00867429001      00-867429-001  
00886609000      00-886609-000      324172  
8674291      867429-1      886609

**376490**



**Bouchon Ø 22 mm**

01240028001      01-240028-001      012400281  
01-240028-1

**Groupe de lavage**

**392681**



**Bouchon bras de rinçage Ø 24,5 mm**

01245080002

01-245080-002

**339694**



**Injecteur bras de lavage, LTB**

139321-31

139321-32

E140008

**339698**



**Injecteur bras de rinçage**

139321-34

E140007

**376270**



**Tige bras de rinçage**  
écrou CH32, Ltot.=31,5 mm

00324067000

00-324067-000

324067

**317702**



**Injecteur bras de rinçage Ø 2,5 mm**

139321-952

E140025

**455971**



**Support injecteur rinçage**

E926131

**376098**



**Support pour bras de lavage H=72 mm**

01240631002  
01-240631-2

01-240631-002

012406312

**376066**



**Raccord Ø 23 mm - Ltot=55 mm**

01240159001  
01-240159-1

01-240159-001

012401591

**386898**



**Raccord 90° sortie Ø 18 mm**

00324097000

00-324097-000

324097

**398474**



**Agrafe de tuyau Ø 26xh10 mm**

00775512001  
775512-1

00-775512-001

7755121

## Groupe de lavage

**376088**

**Baguette bras de lavage avec écrou Ø 22 mm - H=39 mm CH30**

00734803001  
734803-1

00-734803-001

7348031

**376097**

**Écrou support bras de lavage Ø 11,7x32x3 mm**

00231893001  
231893-1

00-231893-001

2318931

**392117**

**Écrou 1"1/2 L=45 mm**

01240631001  
01-240631-1

01-240631-001

012406311

**376102**

**Écrou Ø 34,5x7,5 mm CH 30 mm**

00324384000

00-324384-000

324384

**376099**

**Écrou support bras de lavage Ø 60 mm**

01240021001  
01-240021-1

01-240021-001

012400211

**389262**

**Écrou**

01515112001  
01-515112-1

01-515112-001

015151121

**389268**

**Baguette Ø 12x15/18x12,6 mm**

01515088001  
01-515088-1

01-515088-001

015150881

**387026**

**Anneau plastique Ø 50x33,5/37,3x5,5 mm**

00324729000

00-324729-000

324729

**376021**

**Anneau TEFLON Ø 13x24x1 mm**

00774072007  
774072-7

00-774072-007

7740727

**389423**

**Défecteur Øint. 17,5 mm - H=0,8 mm**

01-240016-001  
01515434001

012400161  
01-515434-001

01-240016-1



**Groupe de lavage**

**392107**



Défecteur Ø 21,60x41,40x0,80 mm

01240648001  
01-240648-1

01-240648-001

012406481

**450976**



Défecteur Ø 63xh20 mm

E199058

**389291**



Vis système de rinçage L=25 mm

01515172001  
015151721  
01-515172-2

01-515172-001  
01-515172-1

01-515172-002  
015151722

**376268**



Tige de bras de rinçage

01240095001  
01-240095-1

01-240095-001

012400951

**452765**



Joint Ø 40x44x3 mm

E303032

**339904**



Collier injecteur de rinçage

139321-33

E429006

**453760**



Joint 76x76x2 mm  
Øint. 49 mm

437064

**Vanne de vidange**

**399687**



Vanne de vidange 180° - 1 voie - 240V  
50Hz  
entrée Ø 17 mm; sortie Ø 20 mm; F6.3x0.8 mm  
- eau chaude

00323785002  
00-323785-012  
3237852

00-323785-002  
32378512  
323785-2

00323785012  
323785-12

**376116**



Vanne de vidange 180° - 1 voie - 230V  
50Hz 0,5bar  
entrée Ø 17 mm; sortie Ø 20 mm - eau chaude

00-323785-001  
3237851  
323785-11

00323785011  
323785-1

00-323785-011  
32378511

**Vanne de vidange**

**406573**



**Joint vanne de vidange [Kit]**  
Joint torique 2,62x45,69 mm; joint Ø 29 mm

ML75068

**Chambres air**

**340129**



**Vis pour chambre de compression M8 - Ltot.=28 mm CH19**

139321180

**339960**



**Raccord en T Ø 8,4x20xh14 mm**  
raccord cannelé Ø 5 mm

00-139321-180  
139321202

00-139321-202  
139321-202

139321-180  
897923

**387058**



**Écrou chambre de compression**  
H=20 mm

00324183000

00-324183-000

324183

**389167**



**Écrou**  
H=6,3 mm

0011619800003  
116198-3

00-116198-00003

1161983

**389393**



**Chambre de compression [KIT]**  
dim. 205x145 mm; portagomma Ø 10,50 mm

01515331002  
01-515331-2

01-515331-002

015153312

**389394**



**Chambre de compression [KIT]**  
dim. 205x145 mm; embout tuyau Ø 10,50 mm

01515331001  
01-515331-1

01-515331-001

015153311

**376496**



**Chambre de compression [KIT]**  
mod. ECOMAX avec adoucisseur

00775540001  
01297510001  
012975101  
01-297510-2  
012976951  
775540-1

00-775540-001  
01-297510-001  
01-297510-1  
01297695001  
01-297695-1  
895457

00-895457-000  
01-297510-002  
012975102  
01-297695-001  
7755401

**317923**



**Chambre de compression Øext 34,5x80 mm**

E107005

## Chambres air

376500

**Chambre de compression**

embout tuyau Ø 13 mm; mod. ECOMAX 602-1C sans adoucisseur

00775759001  
775759-1

00-775759-001

7757591

315746

**Chambre de compression 84x81x42mm**

avec raccord, collier de serrage bifilaire, joint torique et vis

00139321047  
139321-47

00-139321-047

13932147

376462

**Chambre de compression [Kit]**

O-ring Ø 3x24 mm

01240372001  
01-240372-1  
01-246204-101-240372-001  
01-246204-001012403721  
012462041

389405

**Chambre de compression [KIT]**

embout tuyau Ø 6,3 mm

01-515236-001  
01515334001  
01-515334-1015152361  
01-515334-00101-515236-1  
015153341

389377

**Connexion chambre de compression**

embout tuyau Ø 10,50 mm

01515134001  
01-515134-1  
01515332101-515134-001  
01515332001  
01-515332-1015151341  
01-515332-001

## Doseurs, Doseur péristaltique

315729

**Doseur hydraulique produit de rinçage**

IN Ø 6x8 mm - OUT Ø 6x8 mm

139321-499V

E987023

361240

**Doseur hydraulique de rinçage débit réglable 1÷5 cc.**

mod. DIB-5E; connection EV-surchauffeur - IN 180° et OUT 180° pour tuyau de Ø 4x6 mm

E209025

383426

**Doseur péristaltique rinçage débit fixe (U. interne)**

mod. PG-0,4; débit fixe 0,4 L/h; 1 bar; 230V 50/60Hz; câble L=430 mm; tuyau en sekobril; protection 197x124x0,15 mm PVC

00-775556-001  
775556100897930000  
775556-100-897930-000  
897930

610863

**Doseur péristaltique rinçage débit fixe (U. interne)**

mod. NPG-0,4; débit fixe 0,4 L/h; 3 bar; 230V 50/60Hz; câble L=200 mm; tuyau en sekobril; cpl. Kit d'installation

00775556011  
775556-11

00-775556-011

77555611

## Doseurs, Doseur péristaltique

**389243**

**Doseur péristaltique rinçage débit fixe (U. interne)**  
 mod. NPG-1,6; débit fixe 1,6 L/h; 1 bar; 230V 8W 50/60Hz; câble L=340 mm; tuyau en sekobrill

01-515269-001    01515269006    01-515269-006  
 015152691    01-515269-1    015152696  
 01-515269-6

**389247**

**Doseur péristaltique rinçage débit fixe (U. interne)**  
 230V 50/60Hz 4,9/5,4W

01515268001    01-515268-001    015152681  
 01-515268-1

**392451**

**Doseur péristaltique rinçage (U. interne)**  
 DSP9911/03-AH; 1,3 L/h 1 bar; 4,9/5,4W 230V 50/60Hz

01240195001    01-240195-001    012401951  
 01-240195-1

**376111**

**Doseur péristaltique lavage débit fixe (U. interne)**  
 mod. PG-3; débit fixe 3 L/h; 0,1 bar; 230V 8W 50Hz câble L=760 mm; tuyau en Santoprene

00775556012    00-775556-012    77555612  
 775556-12

**383425**

**Doseur péristaltique lavage débit fixe (U. interne)**  
 mod. PG-3; débit fixe 3 L/h; 0,1 bar; 230V 50Hz; câble L=470 mm; tuyau en Santoprene; protection 197x124x0,15 mm PVC

00-775556-002    00897931000    00-897931-000  
 7755562    775556-2    897931

**700431**

**Doseur péristaltique lavage débit réglable (U. interne)**  
 mod. PBR-3; réglage débit 0,3+3 lt/h 0,1 bar; 230V 50Hz; câble L=200 mm; cpl. Kit d'installation

E209016

**376109**

**Doseur péristaltique lavage débit fixe**  
 débit fixe 3 L/h; 0,1 bar; 230V 50/60Hz; 4,9/5,4W; câble L=740 mm

01240195002    01-240195-002    012401952  
 01-240195-2

**389259**

**Doseur péristaltique lavage 230V 50/60Hz 4,9/5,4W**  
 raccord embont Ø 4,6 mm; câble L=350 mm

01515268002    01-515268-002    015152682  
 01-515268-2

**410181**

**Tuyau doseur rinçage sekobrill**  
 L=175 mm - raccord Ø 4x6 mm

00775608001    00-775608-001    7756081  
 775608-1

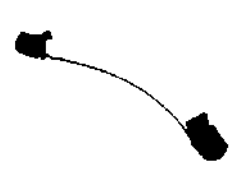
**410180**

**Tuyau doseur lavage Santoprène Ø 6,25x10,55 mm**  
 L=180 mm - raccord Ø 4x6 mm

00775608002    00-775608-002    775608-02  
 7756082    775608-2

## Doseurs, Doseur péristaltique

**398105****Tuyau doseur rinçage sekobrill**

Ø 6,25x10,55 mm - L=180 mm - raccord Ø 4x6 mm

00775608003  
775608-3

00-775608-003

7756083

**392406****Tuyau doseur rinçage**

Øest. 6,5 mm, raccord Ø 4/4,5 mm

00-883860-011  
0124019511  
01-515268-011  
8838601101240195011  
01-240195-11  
0151526811  
883860-1101-240195-011  
01515268011  
01-515268-11**392477****Tuyau doseur lavage**

Øest. 8 mm; raccord Ø 4/4,5 mm

00-883860-012  
0124019512  
01-515268-012  
8838601201240195012  
01-240195-12  
0151526812  
883860-1201-240195-012  
01515268012  
01-515268-12**365039****Tuyau en PVC Ø 4x6 mm (vendu au mètre)**00-324402-000  
00-898252002  
01-246301008  
01-246301-016  
01-246301-08  
0124630116  
01-2463018  
01515410002  
01515410016  
01-515410-099  
32440299  
77560100-324402-099  
00-898252-002  
01-246301-008  
0124630108  
01246301099  
01-246301-16  
01-246301-8  
01-515410-002  
01-515410-016  
01-515410-2  
324402-99  
898252200-493424-000  
01246301008  
01246301016  
01-24630108  
01-246301-099  
012463018  
01-246301-99  
01-515410-008  
01515410099  
324402  
493424  
898252-2**399464****Tuyau en PVC Ø 4x7x1640 mm**00324402002  
324402-2

00-324402-002

3244022

**395592****Tuyau en PVC transparent Ø 4x6 mm L=1900 mm**01-246145-002  
01246301002  
01-246301-2  
01515410-2012461452  
01-246301-002  
01246301-201-246145-2  
012463012  
015154102**200253****Tuyau en PVC transparent Ø 4x6 mm L=2660 mm**00898252003  
00-898252-005  
01-24630110  
01-515410-010  
898252300-898252-003  
01-246301-010  
01-246301-10  
01-51541010  
898252-300898252005  
0124630110  
01515410010  
01-515410-10  
8982525**410462****Tuyau en PVC transparent Ø 4x6 mm L=4000 mm**01-246145-001  
01246301001  
01-246301011  
01-246301-1  
01515410001  
12463011012461451  
01-246301-001  
01-246301-011  
0124630111  
01-515410-001  
1515410101-246145-1  
01246301011  
012463011  
01-246301-11  
01-515410-011

## Doseurs, Doseur péristaltique

389406



Tuyau Ø 4x6x600 mm avec écrou

01515436001  
01-531719-001

01-515436-001

01531719001

399470

Tuyau en PVC transparent Ø 4x7 mm  
L=780 mm00324402013  
324402-13

00-324402-013

32440213

399473

Tuyau en PVC transparent Ø 4x7 mm  
L=950 mm00324402001  
015152931  
324402-100-324402-001  
01-515293-101-515293-001  
3244021

339721

Tuyau en PVC vert Ø 4x7 mm [vendu au  
mètre]

139321-200

3244025

E143013

376231



Tuyau PE bleu Ø 8x10x40 mm

01246210001  
01-246210-1

01-246210-001

012462101

410373

Filtre d'aspiration in inox pour tuyau Ø  
4x6 mm00775239001  
775239100-775239-001  
775239-1775239-01  
E121075

323214

Diaphragme pour doseur  
dim 39x39x31 mm; Øint. 18/est. 25 mm

E199012

392446



Bac a produit de rinçage

01240054001  
01-240054-1

01-240054-001

012400541

392459

Bac a produit de rinçage  
dim. 270x157x40 mm01240174001  
01-240174-1

01-240174-001

012401741

376316

Raccord 1/8" - L=44 mm  
pour tuyau Ø 5 mm01240452001  
01-240452-1

01-240452-001

012404521

## Doseurs, Doseur péristaltique

**394393****Raccord en T Ø 11-6-11 mm**

01-297803-001  
01297816001  
01-297816-1

012978031  
01-297816-001

01-297803-1  
012978161

**376095****Ecrou M9x1**  
pour tuyau Ø 6 mm

00775507001  
775507-1

00-775507-001

7755071

**376312****Raccord Ø 5 mm [KIT]**  
fileté M10

00883676001  
8836761  
883676-2

00-883676-001  
883676-1

00-883676-002  
8836762

**311413****Raccord 90° M12 mm inox**  
pour tuyau Ø 4x6 mm

E468151

## Electrovannes et Réducteurs

**376126****Electrovanne 180° - 1 voie - 230V 50/60Hz - Ø 10,5 mm**  
avec fastons; entrée Ø 3/4" avec filtre et entrée réducteur 5lt/min ; Tmax 90° C (RPE)

00883658001  
012461641  
883658-1

00-883658-001  
01-246164-1

01-246164-001  
8836581

**376113****Electrovanne 180° - 1 voie - 220/240V 50/60Hz - Ø 10,5 mm**  
avec fastons; entrée Ø 3/4" avec filtre et entrée réducteur 15lt/min ; Tmax 90° C (RPE)

00883658002  
012461643  
883658-2

00-883658-002  
01-246164-3

01-246164-003  
8836582

**315708****Electrovanne 180° - 1 voie - 220/240V 50/60Hz - Ø 10,5 mm**  
avec fastons; entrée Ø 3/4" avec filtre et reducteur entrée 5,5 lt/min; Tmax 90°C

00371450022  
371450-22

00-371450-022

00-371450-22

**200124****Electrovanne 180° - 2 voies - 220/240V 50/60Hz - Ø 10,5 mm**  
avec fastons; entrée Ø 3/4" avec filtre; Tmax 90°C

139321-65

E240003

MRTFOC00203

**390777****Electrovanne en laiton 3/8" FF 9W 110/120V 50/60Hz**  
corps L=64,3 mm

0027100600001  
271006-1

00-271006-00001

2710061

**388975****Electrovanne en laiton G1/2" 220/240V 50/60Hz**  
L=95 mm; bobine 220/240V 50/60Hz 9,6W; membrane in PTFE; Psteam 2-50 PSI

0011209100002  
112091-2

00-112091-00002

1120912

## Electrovannes et Réducteurs

**398467**

**Bobine 230V 50/60Hz**  
pour electrovanne 376114

00775530301  
775530-301

00-775530-301

775530301

**582098**

**Service KIT**  
pour electrovanne 388974 en 388975

00-114299

114299

**376125**

**Electrovanne 90° - 1 voie - 220/240V**  
**50/60Hz - Ø 14,5 mm**  
avec fastons; entrée Ø 3/4" avec filtre et  
reducteur - sortie Ø 14,5 mm

00324207001  
324207-1

00-324207-001

3242071

**376114**

**Electrovanne 180° - 1 voie - 220/240V**  
**50/60Hz - Ø 10 mm**  
avec fastons; entrée/sortie Ø 10 mm

00775897001  
775897-1

00-775897-001

7758971

**312594**

**Réducteur de pression en sortie 0,5**  
**lt/min [rouge-Elbi]**

E133009

## Vannes sphériques, Raccords

**339989**

**Raccord cannelé - sortie Ø 6 mm**  
L=28 mm; CH13

E468117

**339995**

**Equerre angulaire 1/4" - Ø 12 mm**

E108006

**376307**

**Raccord en T Ø 17,5 - 13,5 - 13,5 mm**  
dim. 80x40 mm

00324071000  
324071

00-324071-000  
324071-1

00-324071-001

**450850**

**Raccord en Y Ø 12-12-12 mm**

E143173



**Vannes sphériques, Raccords**

**321603**



**Valve anti-réflux 1/2"**  
raccord cannelé Øext 12 mm

00735532817      00-735532-817      735532817  
735532-817      E144010NT

**386900**



**Valve anti-réflux L=123 mm**

00324091000      00-324091-000      324091

**398245**



**Valve anti-réflux double**  
embout cannelé Ø 14 mm - Ø 17 mm; dim.  
85x52 mm

00775846001      00-775846-001      7758461  
775846-1

**376498**



**Valve anti-réflux Ø 19 mm - L=100 mm**  
embout cannelé Ø 10 mm

01240142001      01-240142-001      012401421  
01-240142-1      01-240144-001      012401441  
01-240144-1      01-240145-001      012401451  
01-240145-1

**389518**



**Valve anti-réflux [KIT]**  
embout cannelé Ø 10,50; entrée/sortie Ø 22  
mm

00883817002      00-883817-002      01-510300-001  
01510300002      01-510300-002      015103001  
01-510300-1      01510300-1      015103002  
01-510300-2      01-51031      01-510552-001  
01510552002      01-510552-002      015105521  
01-510552-1      015105522      01-510552-2  
8838172      883817-2

**376417**



**Bouchon Ø 10 mm**

00775531001      00-775531-001      7755311  
775531-1

**400574**



**Valve anti-réflux 1/2" FF 180°F/125psi**

0029290900003      00-292909-00003      2929093  
292909-3

**400346**



**Valve anti-réflux 1/2" FF 180°F/125PSI**

0029290900002      00-292909-00002      2929092  
292909-2

**394464**



**Ecroe pour valve anti-réflux**  
CH30 - 389518

01297502001      01-297502-001      012975021  
01-297502-1

## Tuyaux

340137



Tuyau formé Ø 10x15 mm  
dim. 160x85 mm

E143106

407686



Tuyau formé Ø 30x38x84 mm

00781335001  
781335-1

00-781335-001

7813351

382800



Tuyau formé [Kit]

raccords 45° Ø 30x38x84 mm; raccords 90° Ø 30x38 mm dim. 100x100 mm; agrafe de tuyau Ø 35-40 mm

00-781336-001  
781336100896964000  
781336-100-896964-000  
896964

582963



Tuyau formé Ø 41,40x50,50 mm - L= 78 mm

01-240164001  
01-240164101-240164-001  
01-240164-1

012401641

392467



Tuyau formé Ø 15,5x23 mm - Ø 25x33,5 mm  
dim. 520x245x50 mm

01240168001  
01-240168-1

01-240168-001

012401681

392466



Tuyau formé Ø 18x26 mm - Ø 23x30 mm

01240169001  
01-240169-1

01-240169-001

012401691

409506



Manchon Ø 26x32,5x40 mm

00883145003  
8831453  
883145-700-883145-003  
883145-300-883145-007  
8831457

318526



Tuyau formé 90° Ø int 49 mm

E127041

324780



Tuyau formé Ø 40/48x80 mm

E127082

387128



Tuyau formé  
dim. 180x130x30 mm; M24; CH 30

00300707000

00-300707-000

300707

**Tuyaux**

**200005**



Tuyau en EPDM Ø 5x12 mm (vendu au mètre)

E143005

**402829**



Tuyau en EPDM Ø 5x12 mm L=1000 mm

00-139321-127  
139321127  
371450-173

00371450173  
139321-127

00-371450-173  
371450173

**392454**



Tuyau EPDM Ø 10x17 mm L=1000 mm

01240181001  
012401811  
01-240181-2

01-240181-001  
01-240181-1

01-240181-002  
012401812

**398378**



Tuyau EPDM Ø 10x17 mm L=505 mm

00775559018  
775559-18

00-775559-018

77555918

**398391**



Tuyau EPDM Ø 10x17 mm L=640 mm

00775559019  
775559-19

00-775559-019

77555919

**398398**



Tuyau EPDM Ø 10x17 L=820 mm

00775559012  
775559-12

00-775559-012

77555912

**200002**



Tuyau en EPDM Ø 12x19,5 mm (vendu au mètre)  
pour eau chaude - Pmax 10 bar - temp. de travail -35°C+120°C

E143010

**392465**



Tuyau EPDM Ø 13x20 mm L=600 mm  
90 bar

01240170001  
01-240170-1

01-240170-001

012401701

**376469**



Tuyau en silicone Ø 10x15 mm L=1000 mm

00774080001  
774080-1

00-774080-001

7740801

**339959**



Tuyau d'alimentation en caoutchouc 3/4" L=1500 mm  
raccord droit + raccord coudé 90° en plastique; écrou en nylon Ø 3/4"F; tuyau Ø 13x19 mm; Pmax 10 bar; Tmax 90°C; certifié WRAS/VDE

E143170

## Tuyaux

524404



**Tuyau d'alimentation recouvert d'acier  
3/4" L=2000 mm DN13**  
raccord droit + raccord coudé 90°; ecrou en  
laiton-nickel Ø 3/4"F; Pmax 25 bar; Tmax  
100°C; certifié WRAS

012403161

376219



**Kit tuyau d'alimentation**  
tuyau flexible 3/4" 90°/180° L=1900 mm; tuyau  
EPDM Ø 10x16 mm L=1200 mm

00-775552-001	00-775552-002	00895495000
00-895495-000	00-898045-001	00-898045-004
01-246176-001	012461761	01-246176-1
01-246177-001	012461771	01-246177-1
7755521	775552-1	7755522
775552-2	895495	8980451
898045-1	8980454	898045-4

376485



**Tuyau de vidange PPE Ø 19 mm 180° - Ø  
19 mm 180° L=2100mm**  
raccords Øint./est. 19/25 mm; tuyau Øest. 25  
mm

00324045000 00-324045-000 324045

438247



**Tuyau de vidange PPE Ø 21 mm 180°+ Ø  
30 mm M 180° L=2150 mm**  
raccords Øint/ext 21/28 mm et 30/34 mm,  
tuyau Øext 26,5 mm

00323801001	00-323801001	00-323801-001
003238011	00-323801-1	3238011
323801-1		

700443



**Tuyau de vidange PPE Ø 21,5mm 180°+ Ø  
21,5mm 180° L=630 mm**  
raccords Øint/ext 21,5/26 mm, tuyau Øext 24  
mm, Clean 3

E127037

700445



**Tuyau de vidange PPE Ø 28 mm 180°+ Ø  
24 mm 180° L=1500 mm**  
raccords Øint/ext 28/33 mm et 24/29 mm,  
tuyau Øext 29,5 mm

E143178

700444



**Tuyau de vidange PPE Ø 22,5 mm 180°+ Ø  
22 mm M 180° L=280 mm**  
raccords Øint/ext 22/27,5 mm, tuyau Øext  
22,5 mm

E127044

376484



**Tuyau de vidange PPE Ø 22 mm 90° + Ø  
19 mm 180° L = 2000 mm**  
manchon 180° Ø int/ext 19/25 mm, 90° ext  
Øint/manche 22/28 mm, 25 mm tube Øext

00371450111	00-371450-111	00883961001
00-883961-001	00883961002	00-883961-002
01-243347-001	012433471	01-243347-1
371450111	371450-111	8839611
883961-1	8839612	883961-2

Traitement de l'eau

**375148**



**Adoucisseur 220/240V 50/60Hz**

00775918001      00-775918-001      7759181  
775918-1

**398468**



**Adoucisseur 220/240V 50/60Hz**  
dim. 210x230x205 mm

00-775530-001      00775530002      00-775530-002  
7755301      775530-1      7755302  
775530-2

**376082**



**Couvercle adoucisseur [KIT]**

00775530050      00-775530-050      77553050  
775530-50

**389584**



**Couvercle adoucisseur Ø 85,60 mm [KIT]**

01515030050      01-515030-050      0151503050  
01-515030-50

**376080**



**Couvercle adoucisseur [KIT]**  
joint Ø 55x72x3 mm

00-775918-050      00775918150      00-775918-150  
775918150      775918-150      77591850  
775918-50

**582130**



**Cartouche osmose inverse 1812 100GPD**  
avec 2 O-ring 2x14 mm

01294282101      01-294282-101

**459756**



**Cartouche carbone**  
H=275 mm

01-294225-001      012942251      01-294225-1  
01-294225-101      12942251      1294225101

Composants de vidange

**450797**



**Collecteur de vidange**  
dim. 158x160x110 mm

E136030

**376084**



**Collecteur de vidange Ø 75x105xh110 mm**  
tuayu Ø 31 mm

00323802001      00-323802-001      3238021  
323802-1

**Composants de vidange**

**376158**



Bride avec joint Ø 70x107 mm

00-324053-000 00886639000 00-886639-000  
324053 886639

**376174**



Joint Ø 80x100xH3,85 mm

00324056000 00-324056-000 324056

**392022**



Tuyau de trop-plein Ø 32/90x160 mm

01-240629-001 012406291 01-240629-1  
01-240744-001 01240744002 01-240744-002  
012407441 01-240744-1 012407442  
01-240744-2

**403434**



Tuyau de trop-plein Ø 22x168 mm

E142051

**450834**



Tuyau de trop-plein Ø 35x147 mm

E142052

**Filtres**

**398232**



Filtre Ø 106 mm

00775750001 00-775750-001 7757501  
775750-1

**395284**



Filtre 85x74 mm

01245377001 01-245377-001 012453771  
01-245377-1

**394107**



Filtre de cuve 423x158/188 mm

01294115001 01-294115-001 012941151  
01-294115-1

**388249**



Filtre de cuve 492x225/247 mm

00231958000 00-231958-000 231958

**Filtres**

**392363**



Filtre de cuve 530x220 mm

01240051011      01-240051-011      01-240051-012  
 0124005111      01-240051-11      0124005112  
 01-240051-12

**318930**

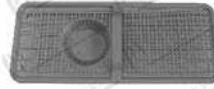

Filtre de cuve 525x217 mm

01240051004      01-240051-004      012400514  
 01-240051-4

**392285**



Filtre de cuve Ø 145 mm

01240003002      01-240003-002      012400032  
 01-240003-2

**376156**



Filtre de cuve Ø 136 mm H=47 mm

01240630003      01-240630-003      012406303  
 01-240630-3

**376149**



Filtre de cuve Ø 32,5x130x50 mm

01-240630-001      01240630002      01-240630-002  
 012406301      01-240630-1      012406302  
 01-240630-2

**403060**



Ecrou Ø 20,7x13 mm

E408006

**323930**



Filtre Ø 24x88/122xh68 mm

139321744      E121100

**453614**



Filtre support Ø 142xh135 mm

E80470

**450374**



Filtre Ø 153x120 mm

E121052      E121081

**453637**



Filtre Ø 93x180xh37 mm

E429072

**Composant structuraux**

**394465**



**Cover**

01297500001      01-297500-001      012975001  
01-297500-1

**380928**



**Protection 500x270x1 mm**

00494213000      00-494213-000      494213

**392436**



**Deflektor 207x50 mm**

01240085001      01-240085-001      012400851  
01-240085-1

**583082**



**Deflecteur 180x35x0,25 mm**

00918228      00-918228      918228

**402716**



**Levier de vidange L=110 mm**

00375215001      00-375215-001      3752151  
375215-1

**Portes**

**392445**



**Porte 600x470 mm**  
FX/GX & FP/GP

01-240055-001      01240055002      01-240055-002  
012400551      01-240055-1      012400552  
01-240055-2

**Poignées**

**392457**



**Poignée porte**  
dim. 200x25 mm; trou Ø 6,5 mm; distance de fixation 120 mm

01240177001      01-240177-001      012401771  
01-240177-1

**392476**



**Poignée porte**  
dim. 200x30 mm; distance de fixation 167 mm

01240133001      01-240133-001      012401331  
01-240133-1



**Charnières**

**376274**



**Axe pour charnières M5 Ø 8x15 mm**  
Ltot.=21 mm

01240151001      01-240151-001      012401511  
01-240151-1

**395563**



**Fixation rapide Ø 10 mm**

01246464001      01-246464-001      012464641  
01-246464-1

**376036**



**Bloc charnière 52x18x10 mm**

01294108001      01-294108-001      012941081  
01-294108-1

**392033**



**Charnière droite**  
dim. 80x30 mm

01240709002      01-240709-002      012407092  
01-240709-2

**392434**



**Charnière droite**

01240092001      01-240092-001      012400921  
01-240092-1

**392448**



**Charnière gauche**

01240092002      01-240092-002      012400922  
01-240092-2

**392452**



**Couverture charnière**

01240194001      01-240194-001      012401941  
01-240194-1

**Thermomètres**

**402133**



**Thermomètre Ø 52 mm 40=105°C**  
bulbe Ø 11x66 mm; capillaire L=2450 mm;  
presse étoupe Ø 15,5 mm CH16 mm

00-276923-00006      0043704100003      00-437041-00003  
2769236      276923-6      4370413  
437041-3

## Composants Mécaniques

### Collier de serrage avec vis



<b>376136</b>	Ø 17 mm		<b>323945-40</b>
<b>376140</b>	Ø 29 mm		<b>323945-29</b>
<b>376141</b>	Ø 34 mm		<b>323945-33</b>
<b>376143</b>	Ø 37 mm		<b>323945-37</b>
<b>376144</b>	Ø 53 mm		<b>323945-53</b>
<b>376145</b>	Ø 56 mm		<b>323945-56</b>
<b>376147</b>	Ø 64 mm		<b>323945-64</b>
<b>376135</b>	Bifilaire	Ø 15 mm	<b>323945-15</b>
<b>376137</b>	Bifilaire	Ø 18 mm	<b>323945-18</b>

<b>376138</b>	Bifilaire	Ø 21,50 mm	<b>323945-21</b>
<b>399773</b>	Bifilaire	Ø 23 mm	<b>323945-22</b>
<b>399659</b>	Bifilaire	Ø 23,50 mm	<b>323945-23</b>
<b>376139</b>	Bifilaire	Ø 25 mm	<b>323945-25</b>
<b>399829</b>	Bifilaire	Ø 35÷40 mm	<b>323945-40</b>
<b>376142</b>	Bifilaire	Ø 35 mm	<b>323945-35</b>
<b>399827</b>	Bifilaire	Ø 50 mm	<b>323945-49</b>
<b>399826</b>	Bifilaire	Ø 69 mm	<b>323945-68</b>
<b>399824</b>	Bifilaire	Ø 78 mm	<b>323945-76</b>

### Collier de serrage bifilaire



<b>399494</b>	Ø 6,3+7 mm		<b>324510-73</b>
<b>399494</b>	Ø 6,6+7 mm		<b>324510-81</b>
<b>399493</b>	Ø 7,3+7,8 mm		<b>324510-86</b>
<b>380343</b>	Ø 8,8+9,3 mm (5 pcs)		<b>324510-68</b>
<b>399518</b>	Ø 14,8+15,9 mm		<b>324510-173</b>
<b>376131</b>	Ø 17,7+18,7 mm		<b>324510-202</b>
<b>399501</b>	Ø 19,7+20,6 mm		<b>324510-192</b>
<b>376132</b>	Ø 21+23 mm		<b>324510-242</b>

<b>399497</b>	Ø 27,00+31,80 mm		<b>324510-313</b>
<b>399499</b>	Ø 22,00+23,70 mm		<b>324510-258</b>
<b>399498</b>	Ø 25,00+27,00 mm		<b>324510-287</b>
<b>376133</b>	Ø 27,60+29,20 mm		<b>324510-327</b>
<b>582968</b>	Ø 30,70+32,90 mm		<b>024510-356</b>
<b>399496</b>	Ø 33,20+34,80 mm		<b>324510-341</b>
<b>582967</b>	Ø 33,80+36,30 mm		<b>324510-388</b>
<b>582966</b>	Ø 35,20+39,20 mm		<b>324510-429</b>

## Composants mécaniques

**402708**

Circlip Ø 18,5/20x1,2

00372955001  
372955-100-372955-001  
QA011463729551  
QA011-46**402815**

Circlip Ø 35x1,5 mm

00374960001  
374960-1

00-374960-001

3749601

**381454**

Circlip INOX Øest. 10,8x0,7 mm

00602950000  
RR-E-2-2700-602950-000  
RRE2-27

602950

**376017**

Anneau Ø 41x46x3 mm

00775933001  
00-775933-003  
015153561  
7759331  
775933-300-775933-001  
01515356001  
01-515356-1  
775933-100775933003  
01-515356-001  
01515356-1  
7759333**376065**

Anneau Ø 45x3 mm

00324068000

00-324068-000

324068

**399647**

Amortisseur Ø 14xhtot.7 mm

00323785101  
323785-101

00-323785-101

323785101

**376148**

Butée de porte 7,5x17x10 mm

01240741001  
01-240741-1

01-240741-001

012407411

**376039**

Bride bague Ø 8x10/15x4 mm

01240176001  
01-240176-1

01-240176-001

012401761

**439006**

Clavette 6x6x25 mm - INOX

00298687002  
298687-2

00-298687-002

2986872

**376083**

Goupille fendue Ø 2,7x18mm

00602886000

00-602886-000

602886

## Composants mécaniques

438438



Ecoux hexagonal M6 autofreïés - INOX

00602502000 00-602502-000 602502

322630



Ecoux hexagona M8x8 INOX indesserrable

0016340900002 00-163409-00002 00-602503-000  
1634092 163409-2 602503

582965



Ecoux hexagona M8 - INOX

00-602492-000 602492 602492000

418034

Ecoux hexagonal borgne M6  
H=11,5 mm

00603036000 00-603036-000 603036

455560



Ecoux molette plate M10 Ø 25 mm H=4 mm

E80697

376094



Ecoux molette plate M12x1 Ø 32 mm H=3 mm

00-324036-000 01240205001 01-240205-001  
012402051 01-240205-1 324036

582964

Collier de serrage plastique H=2,50 mm  
÷ L=160 mm00165128001 00-165128-001 00-699734-387  
1651281 165128-1 699734387  
699734-387

395615



Collier de serrage Ø 7 mm H=8,66 mm

01246214003 01-246214-003 012462143  
01-246214-3 01-510143-001 015101431  
01-510143-1

395616



Collier de serrage Ø 17 mm

01246214002 01-246214-002 012462142  
01-246214-2

395617



Collier de serrage Ø 23÷27/12 mm

01246214001 01-246214-001 012462141  
01-246214-1

## Composants mécaniques

409464



Bouchon Ø 35 mm

00883271001  
883271-1

00-883271-001

8832711

401518



Rouleau Ø 59,50 mm H=17,4 mm

00377373003  
377373-3

00-377373-003

3773733

376410



Bouchon Ø 10/15xh18 mm

00774512001  
774512-1

00-774512-001

7745121

382085



Guide L=140 mm

00375213000

00-375213-000

375213

395654

Bouchon Ø 72 mm  
filée M10x18 mm00-229585-000  
01248160101248160001  
01-248160-101-248160-001  
229585

385249



Plaque de fixation 54,4x15,3 mm

00142413000

00-142413-000

142413

325216



Plaque 25x84x2 mm

00898598001  
898598-1

00-898598-001

8985981

325458



Outil d'extraction ventilateur

01-240303-001  
01-240303-1  
01240303301-240303-002  
012403032  
01-240303-3012403031  
01-240303-2

376365



Rondelle grower Ø 4,2 mm INOX

00602308000  
VC03209  
VC-32-900-602308-000  
VC032-09602308  
VC329

376364

Rondelle plate Ø 8,4x18x0,9 mm  
plastique01240789001  
01-240789-1

01-240789-001

012407891

## Composants mécaniques

364457



Rondelle plate Ø 8,5x16x1,5 mm INOX

00-602287-000  
602287000  
WAME8-36

00-603617-000  
603617

602287  
WAM-E-8-36

322015



Rondelle plate M10 INOX

00602288000

00-602288-000

602288

376020



Rondelle plate Ø 14,90x19,70x0,5 mm - téflon

00774072001  
774072-1

00-774072-001

7740721

376019



Rondelle plate Ø 16x20,50x0,5 mm - téflon

00774072002  
774072-2

00-774072-002

7740722

381382



Vis tête hexagonale M8x25 mm - INOX

00602976000  
00-699739-041  
699739-041  
SC4113

00-602976-000  
602976  
SC04113  
SC-41-13

00699739041  
699739041  
SC-041-13

582729



Vis à tête fendue M5x30 mm inox

SCME1236

SCM-E-12-36

376509



Vis moletée Ø 22mm M10x10mm

00139321107  
139321-107

00-139321-107  
E454002

139321107

## Joint axe

412354



Joint d'étanchéité Ø 24x12x16 /  
contre-joint Ø 26x12x8 mm  
Joint d'étanchéité en TEFLON

E141007

**Fermetures**

**452776**



**Plaque de glissement**  
dim. 19x88xh10 mm

E307003

**389301**



**Aimant 15x12x10 mm**

01515145001  
01-515145-1

01-515145-001

015151451

**392415**



**Aimant avec support [KIT]**  
aimant 20x10x5 mm

01-240293-001  
01-240294-001  
01240295001  
01-240295-1

012402931

012402941

01-240295-001

01-240293-1

01-240294-1

012402951

**394740**



**Aimant support 24,5x45/61x12,5 mm**

01297033001  
01-297033-1

01-297033-001

012970331

**376244**



**Ressort for serrure de porte**  
dim. 45x25mm

01240764001  
01-240764-1

01-240764-001

012407641

**Surchauffeurs**

**398435**



**Surchauffeur 1 Résistances [kit]**  
dim. 400x140x180 mm; raccord cannelé Ø 11 mm

00775306001  
7753061  
775461-1

00-775306-001

775306-1

00-775461-001

7754611

**376353**



**Surchauffeur 1 résistances**  
dim. Ø 110x295 mm - Fast139 - E40F - Fast135 - NG40PP

E104056

**322604**



**Surchauffeur 1 Résistances**  
dim. Ø 145x360 mm - E50 - E51

E104026

**456092**



**Surchauffeur 3 résistances**  
dim. Ø 250x460 mm

E927067

**Surchauffeurs**

**323428**



**Surchauffeur 1 résistances [KIT]**  
dim. Ø 140x405 mm; avec isolant

982019 E982019

**319262**



**Surchauffeur 3 résistances [KIT]**  
dim. Ø 168x450 mm; avec isolant

00323773001 00-323773-001 00-886762-001  
3237731 323773-1 8867621  
886762-1

**Ressort**

**410046**



**Ressorts de compression Ø 8,10 mm**  
L=65 mm

00886839001 00-886839-001 8868391  
886839-1

**387025**



**Ressorts de compression Ø 37x14 mm**

00324730000 00-324730-000 324730

**392378**



**Ressort à gaz 50N Ø 15 mm L=230÷435 mm**

01240229001 01-240229-001 012402291  
01-240229-1

**389395**



**Ressort à gaz 55N Ø 18 mm L=250÷496 mm [KIT]**

01515330001 01-515330-001 015153301  
01-515330-1

**389290**



**Ressort porte Ø 13xLtot. 116 mm [Kit]**

01240244001 01-240244-001 012402441  
01-2402441 01-240244-1 01515292003  
01-515292-003 015152923 01-515292-3

**455960**



**Ressorts de traction Ø 30x450 mm**  
Ltot.=505 mm

E926108

**392381**



**Bague à bride Ø 5,2x7,2/10,80x4,50 mm**

01240204001 01-240204-001 012402041  
01-240204-1

**395069**



**Support ressort Ø 66x32 mm**  
Ø int. 10/est. 54,5/66 mm H=32 mm

01245280001 01-245280-001 012452801  
01-245280-1



**Ressort**

**392374**

**Goujon de sécurité**



01240236001  
01-240236-1

01-240236-001

012402361

**Rails et Montures de grille**

**392430**

**Guide plastique L=112 mm - gauche**



01240098001  
01-240098-1

01-240098-001

012400981

**392429**

**Guide plastique L=112 mm - droite**



01240098002  
01-240098-2

01-240098-002

012400982

**Photocellule**

**388462**



**Réflecteur photocellule Ø 29x6 mm [KIT]**  
vis M3 L=8 mm; rondelle Ø 3,7x19,7x0,8 mm

00887031002	00-887031-002	00-887031-2
01537791001	01-537791-001	015377911
01-537791-1	01537791-1	8870312
887031-2		

**397232**



**Cellule photoelectrique VT18-204470**  
DC 10-230V; temperatura di lavoro  
-25°C....+70°C; connettore M12;4-pin

00695674010	00-695674-010	69567410
695674-10		

**400821**

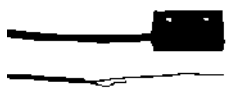

**Récepteur photocellule**  
dim. 35x19.9x12/6 mm; câble L= 5000 mm

00301763006	00-301763-006	3017636
301763-6		

**400822**



**Récepteur photocellule**  
câble L=5000 mm

00301763005	00-301763-005	3017635
301763-5		

**408817**



**Récepteur photocellule**  
dim. 15x47x33 mm

00-887031-001	00887178001	00-887178-001
8870311	887031-1	

**Platines**

**315530**



**Platine électronique**  
K500/500P - ST330/330H

E215029	E215038
---------	---------

**316865**



**Platine électronique (sans processeur)**  
GL71/72/71 - GS55/77 - GOLD43 - LP201 -  
SV71/72

E215023
---------

**392365**



**Platine électronique**  
dim. 145x150xh45 mm - AMX / care-10A /  
Premax / FX/GX & FP/GP / GC/GCP

01240262001	01-240262-001	012402621
01-240262-1		

**Platines**

**376374**



**Platine électronique (sans eprom)**

00-897502-002	00-897502-012	00-897502-015
00-897502-022	00-897502-117	00-897502-217
8975021	897502117	897502-117
89750212	897502-12	89750215
897502-15	8975022	897502-2
897502217	897502-217	89750222
897502-22		

**404418**



**Platine électronique**  
dim. 225x100 mm

00897502011	00-897502-011	89750211
897502-11		

**317682**



**Platine électronique 147x125 mm**  
ECOMAX 402 / ECOMAX 502 / AM

00897545005	00-897545-005	00897545205
00-897545-205	897545-205	8975455
897545-5		

**316869**



**Carte électronique (sans eprom)**  
dim: 145x125 mm - AMX / AUX / FX/GX & FP/GP / ECOMAX 402-602 / GC / GCP

00897545001	00-897545-001	00-897545-002
00897545003	00-897545-003	00897545201
00-897545-201	897545-002	8975451
897545-1	8975452	897545-2
897545-201	8975453	897545-3

**459774**



**Platine électronique**  
dim. 140x92 mm - AM / LX

00-892934-00001	8929341	892934-1
-----------------	---------	----------

**389388**



**Platine électronique**  
dim. 185x270x45 mm

01-515050-001	015150501	01-515050-1
01-515336-001	015153361	01-515336-1
01515340001	01-515340-001	015153401
01-515340-1		

**389387**



**Platine électronique**  
dim. 150x230 mm

01-515050-002	015150502	01-515050-2
01515340002	01-515340-002	015153402
01-515340-2		

**404411**



**Carte électronique d'extension**  
dim. 70x120 mm

00-897546-001	00897546002	00-897546-002
00-897546-003	00897546202	00-897546-202
8975461	897546-1	8975462
897546-2	897546-202	8975463
897546-3		

**Platines**

**389283**



**Carte électronique**  
dim. 193x70 mm

01515051001      01-515051-001      015150511  
01-515051-1

**316870**



**Carte interface utilisateur 184x35 mm**  
AM / ECOMAX

00-897560-001      00897560002      00-897560-002  
8975601      897560-1      8975602  
897560-2

**376378**



**Carte interface utilisateur**  
CNA / UX / UXL / AUX

00897501001      00-897501-001      8975011  
897501-1

**378625**



**Carte interface utilisateur 183x45 mm**

00-897540-001      00-897540-002      00897540201  
00-897540-201      00897540202      00-897540-202  
8975401      897540-1      8975402  
897540-2      897540-201      897540-202

**382836**



**Carte interface utilisateur**  
dim. 95x45 mm; câble L=195 mm - AM / LX

00892458      00-892458      892458

**389466**



**Carte interface utilisateur**  
dim. 50x250 mm - AMX / FX / GX / GC

01515040001      01-515040-001      015150401  
01-515040-1

**582959**



**Carte interface utilisateur HYG DOS**  
FX/GX & FP/GP / GC/GCP

01240040001      01-240040-001      012400401  
01-240040-1

**394092**



**Capteur chimique assemble**  
dim. 57x58 mm

01294204001      01-294204-001      012942041  
01-294204-1

**455718**



**Eprom**

E81000

**321309**



**Eprom FW rev.10.4**

00897503002      00-897503-002      8975032  
897503-2

**Platines**

**582574**



**Eprom FW rev.0.7**

89750317      897503-17

**376128**



**Eprom Rev. L7.1**

00897547017      00-897547-017      89754717  
897547-17

**325610**



**Eprom Rev. 2.9/7401**

00-897547-013      897547-13

**376127**



**Eprom Rev. L2.9**

00897547006      00-897547-006      8975476  
897547-6

**389277**



**Usb port L=1500 MM**

01515064001      01-515064-001      015150641  
01-515064-1

**390328**



**Câble chart**  
L=325 mm; puntale Ø 1,2x1,7 mm

00227073090      00-227073-090      22707390  
227073-90

**408465**



**Connecteur 3 phases**

00785429019      00-785429-019      78542919  
785429-19

**Sondes**

**376064**



**Clip de fixation sonde de température**  
dim. 24,5x35x5 mm

00-324157-000      00775489001      00-775489-001  
324157      7754891      775489-1

**381960**



**Sonde de niveau**  
câble L=230 mm

00329274      00-329274      329274

## Sondes

**398058**

**Sonde de température NTC**  
bulbe Ø 4,7x35,5 mm; câble L=250 mm

00775612002  
775612-2

00-775612-002

7756122

**376388**

**Sonde de température NTC**  
bulbe Ø 5x30 mm, câble L=265 mm

00-738455-000  
738455

00775612001  
7756121

00-775612-001  
775612-1

**392383**

**Sonde de température NTC [Kit]**  
bulbe Ø 5x30 mm; câble L=265 mm + câble  
L=610 mm

01240201001  
012402011  
01-240201-2

01-240201-001  
01-240201-1

01-240201-002  
012402012

**387086**

**Sonde de température Ø 4,7x30,5 mm**  
câble L=2820 mm

00324325000

00-324325-000

324325

**389592**

**Raccord en T für capteur de turbidité**  
Ø 25 mm; L=60 mm

01515021001  
01-515021-1

01-515021-001

015150211

**316825**

**Sonde de température NTC**  
bulbe Ø 5x30 mm; câble L= 390 mm; INOX à  
partir de -40 a +110°C, avec raccord

E231014

E231016

**376389**

**Sonde de température NTC**  
dim. Ø 10x44 mm; rast 5 avec faston 4,8x0,8  
mm

00775494001  
775494-1

00-775494-001

7754941

**381965**

**Sonde de température Ø 4x13 mm**  
Ltot.=27,5 mm; câble L=230 mm

00328994

00-328994

328994

**389593****Capteur de turbidité**

01515020001  
01-515020-1

01-515020-001

015150201

**Membranes**

**404410**



**Membrane adhésive 185x45 mm**  
AM / FX/GX & FP/GP / AMX / AUXXT / GC

00897550001      00-897550-001      00-897557-001  
8975501            897550-1            8975571  
897557-1

---

**404409**



**Membrane adhésive 185x45 mm**  
FX/GX & FP/GP / GCP / GC

00897551001      00-897551-001      8975511  
897551-1

---

**582960**



**Membrane adhésive 250x50 mm**  
PREMAX

01515046001      01-515046001      01-515046-001  
015150461            01-515046-1

---

**389286**



**Membrane adhésive 250x50 mm**  
PROFI

01515045001      01-515045-001      015150451  
01-515045-1

---

**404379**



**Membrane adhésive 500x40 mm**  
UX / UXL / UXT / UXTL

00897500001      00-897500-001      8975001  
897500-1

---

**394376**



**Membrane adhesive 400x45 mm**  
Ecomax

01297749001      01-297749-001      012977491  
01-297749-1

---

**Jointes pour lave-vaisselle**

**376191**



**Joint de porte 560x490 mm**  
FX/GX & FP/GP, PROFI FX - FXL- GX- GX-C /  
PREMAX FP - GP

01240077001      01-240077-001      012400771  
01-240077-1

**398170**

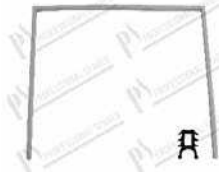

**Joint de porte 426x381 mm**  
GC/GCP, PROFI GC / PREMAX GCP

00-775821-001      00775902001      00-775902-001  
7758211      775821-1      7759021  
775902-1

**397908**



**Joint de porte Ø 8x630 mm**

00774101001      00-774101-001      7741011  
774101-1

**Jointes plats**

**391746**



**Joint en fibre Ø 17x24x2 mm**

00168611009      00-168611-009      1686119  
168611-9

**390374**



**Joint plate Ø 24,50x37x1,50 mm**

00172986025      00-172986-025      17298625  
172986-25

**385202**



**Joint plate Ø 25x34x2 mm**

00172513000      00-172513-000      172513

**376175**



**Joint plate Ø 25,5x34x2,5 mm pour  
chambre air**

00775305001      00-775305-001      7753051  
775305-1

**386458**



**Joint plate Ø 25,4x38x3 mm**

00293014      00-293014      293014

**376170**



**Joint plate Ø 47x60x0,9 mm**

00172986019      00-172986-019      17298619  
172986-19



**Joint plates**

**392456**



Joint plate Ø 90x107x2,5 mm

01240178001      01-240178-001      012401781  
01-240178-1

**397869**



Joint plate Ø 10,50x15x1,65 mm - Teflon

00-168611-017      00774072003      00-774072-003  
16861117      168611-17      7740723  
774072-3

**387458**



Joint Ø 210x260x2,3 mm  
trous Ø 13 mm

00229586000      00-229586-000      229586

**319348**



Joint adhésif 12x2 mm [20 Mt]

00168834006      00-168834-006      1688346  
168834-6

**O-ring**



<b>376247</b>	1,50x6,00 mm	VITON	<b>276903-55</b>	<b>435178</b>	3,53x20,22 mm	VITON	<b>06750-72</b>
<b>373031</b>	1,78x5,28 mm	EPDM	<b>E456009</b>	<b>416272</b>	3,53x23,40 mm	SILICONE	<b>67500-11</b>
<b>337127</b>	1,78x9,25 mm	NBR	<b>E456019</b>	<b>438162</b>	3,53x28,17 mm	VITON	<b>67500-12</b>
<b>456112</b>	1,78x28,30 mm	EPDM	<b>E927094</b>	<b>373114</b>	3,53x47,53 mm	EPDM	<b>276903-21</b>
<b>376250</b>	2,00x24,00 mm	VITON	<b>276903-50</b>	<b>456115</b>	3,53x50,80 mm	EPDM	<b>E927097</b>
<b>438736</b>	2,62x15,54 mm	NBR	<b>609009</b>	<b>400902</b>	5,34x37,47 mm	VITON	<b>303117-1</b>
<b>376254</b>	3,00x25,00 mm	VITON	<b>276903-56</b>	<b>438465</b>	5,34x37,47 mm	EPDM	<b>67500-150</b>
<b>434029</b>	3,00x28,00 mm	EPDM	<b>276903-9</b>	<b>612335</b>	5,34x43,82 mm (3 pcs)	VITON	<b>233982-6</b>
<b>376256</b>	3,00x83,00 mm	EPDM	<b>775465-11</b>	<b>435303</b>	5,34x46,99 mm	NBR	<b>6750081</b>
<b>392404</b>	3,00x143,00 mm		<b>01-240272-001</b>	<b>376261</b>	5,34x47,00 mm	VITON	<b>01-240135-011</b>
<b>379455</b>	3,50x34,00 mm	EPDM	<b>139321-192</b>	<b>435067</b>	5,34x56,52 mm	NBR	<b>67500-118</b>
				<b>453928</b>	5,34x136,50 mm	EPDM	<b>E456076</b>

## Paniers pour lavevaisselles

**391331**

**Panier 385x385xh170 mm avec 3 rangées  
- pour verres**

00139321058  
139321-58

00-139321-058

13932158

## Pieds

**376275**

**Pied M10 - H=10 mm  
Ø 30 mm - H=10 mm**

01294066001  
01-294066-1

01-294066-001

012940661

**398376**

**Pied M10 - L=100 mm  
Ø 30 mm H=10,5 mm**

00775245001  
775245-1

00-775245-001

7752451

**404849**

**Pied réglable INOX 2" - H=155÷230 mm  
vis M10**

00899605003  
899605-3

00-899605-003

8996053



## **Capot**

**Composants Electriques**

**Composants Eau**

**Composants Mécaniques**

**Composants électroniques**

**Joints**

**Accessoires**

**Interrupteurs, Boutons, Sélecteurs**

**383600**



**Sectionneur principal [KIT]**  
dim. 69x120x80 mm

00695530000      00-695530-000      695530

**400801**



**Sectionneur principal [KIT]**  
100A 220/690V; extension Ø 8,50xLtot 215 mm

00301773001      00-301773-001      3017731

**393006**



**Poussoir double O-I Ø 22 mm**  
dim. 30x50 mm; sans contacts

00-738650-001      00740522001      00-740522-001  
00740522-1      7386501      738650-1  
7405221

**316694**



**Interrupteur bipolaire 16A 250V - ROLD**

E80804

**316704**



**Bouton - ROLD**

E227077

**410144**



**Poussoir vert Ø 22 mm**  
sans contacts auxiliaires

00887015022      00-887015-022      88701522  
887015-22

**402613**



**Capuchon bouton poussoir 23x24 mm**

00374331001      00-374331-001      3743311  
374331-1

**376424**



**Boutton 27x27xH35 mm**

00324266001      00-324266-001      3242661  
324266-1

**397964**



**Groupe contacts 250V 6(4)A**  
dim. 22,2x22,2x26 mm; faston 2,8x0,8 mm

00774793005      00-774793-005      7747935  
774793-5

**376228**



**Lentille "Horloge"**  
dim. 16,5x16,5 mm

00324265001      00-324265-001      3242651  
324265-1

**Interrupteurs, Boutons, Sélecteurs**

**410089**



**E'tiquette vidange et remplissage**

dim. 18x27 mm

00887016027  
887016-27

00-887016-027

88701627

**Contacteurs et Relais**

**391087**



**Contacteur 100-K09KF10**

3kW 3P; 230/240V 50/60Hz; 4kW 400V 50/60Hz; 3 cont. NO + 1 aux NO; dim. 53x45x54 mm

00-141440-001  
00740520001  
141440-1  
740520-001

00141440002  
00-740520-001  
1414402

00-141440-002  
1414401  
141440-2

**376077**



**Contacteur LC1K0601M7**

1,5kW 3P; 220/230V 50/60Hz; 2,2 kW 380/415V 50/60Hz; 3 cont. NO + 1 aux NC

00-232478-001  
00695521002  
00-699734-637  
6955211  
695521-2

00695521001  
00-695521-002  
2324781  
695521-1  
699734637

00-695521-001  
00-695521-1  
232478-1  
6955212  
699734-637

**376074**



**Contacteur LC1K09 004U7**

4kW 3P; 230/240V 50/60Hz 440V 4 cont. NO + 1 AUX NC; dim. 57x45x58 mm

00695521062  
69552162  
775599-001

00-695521-062  
695521-62  
7755991

00-775599-001  
775599001  
775599-1

**383201**



**Contacteur C25DNY164A**

7,5kW 3P; 230V bobine 110-120V 50/60Hz; dim. 55x80x95 mm

00-087713-041-2  
87713412

00918322  
87713-41-2

00-918322  
918322

**409676**



**Contacteur C25DNY125A**

5,5kW 3P; 25A; 230V 50/60Hz 7,5kW 460V - bobina 110-120V 50/60Hz; dim. 60x82x95 mm

000877130851  
00-087713-108-1  
87713-108-1

00-087713-085-1  
00-087713851  
87713851

000877131081  
877131081  
87713-85-1

**409698**



**Relais 277Vac 30A NO - 3A NC**

bobine 120Vac

000877140461  
87714-46-1

00-087714-046-1

87714461

**409701**



**Relais 2P 120Vac**

20A 400Vac; faston 6,3x0,8 mm

000877140421  
87714-42-1

00-087714-042-1

87714421

**376319**



**Relais temporisé 0,02s-300h 12-240V**

AC/DC  
dim. 58x18x90 mm

00774103002  
774103-2

00-774103-002

7741032

## Contacteurs et Relais

396914



**Relais temporisé 3-300 sec. 220-240V  
50/60Hz**  
dim. 80x22x78 mm

00493530001  
493530-1

00-493530-001

4935301

## Microinterrupteurs

376207



**Interrupteur fin de course 1NO/1NC**

00228795000

00-228795-000

228795

389238



**Microinterrupteur magnétique Ø  
5,6x25,5 mm**  
câble L=120 mm

01515276001  
01-515276-1

01-515276-001

015152761

376214



**Microinterrupteur magnétique Ø  
5,6x25,5 mm**  
câble L=330 mm

01240288001  
01-240288-1

01-240288-001

012402881

384291



**Microinterrupteur magnétique M8x0,75 L=42  
mm**  
1 NO, 200Vdc/250Vac 1A 50W; câble L=310  
mm

00-738942-000  
738942

00740173000  
740173

00-740173-000

435219



**Microinterrupteur magnétique**  
NO contact 250V 50VA 0,04A - passo 5

00775491001  
775491-1

00-775491-001

7754911

376213



**Microinterrupteur magnétique 100VA  
0,2A 250Vac/dc IP67**  
1 NO; câble L=3900 mm

00229517002  
229517-2

00-229517-002

2295172

402058



**Microinterrupteur magnétique**  
câble L=300 mm

0047310900004  
473109-4

00-473109-00004

4731094

382063



**Interrupteur à flotteur Ø 9,5x63,5 mm**  
raccord 1/4"; câble L=135 mm

00-328486  
00328495  
328495

00328486000  
00-328495

00-328486-000  
328486-000

## Microinterrupteurs

**386736**

**Interrupteur à flotteur Ø 9,5x63,5 mm**  
raccord 1/4"

00289121  
00-936547-00002  
9365472

00-289121  
009365472

0093654700002  
289121

**387661**

**Interrupteur à flotteur Ø 9,5x63,5 mm**  
raccord 1/4"; cavo L=125 mm

00186091

00-186091

186091

**387822**

**Interrupteur à flotteur Ø 9,5x63,5 mm**  
raccord 1/4"; câble L=125 mm

00271621

00-271621

271621

**376209**

**Interrupteur Ø 12x57 mm**  
raccord 1/4"; câble L=2000 mm

00-226282-000  
226282

00226282002  
2262822

00-226282-002  
226282-2

**376164**

**Flotteur avec aimant Ø 45 mm H=33 mm**  
dim: 60x48x33 mm

00122674  
00-122674-000

00-122674  
122674

00122674000

**384849**

**Charnière pour flotteur**  
dim: 20x29x1.5 mm

00112467  
00-112467-000

00-112467  
112467

00112467000

**389485**

**Interrupteur à flotteur Ø 16,5x52 mm**  
filetage M16x2; câble L=3500 mm

01511207001  
01-511207-1

01-511207-001

015112071

**376399**

**Support aimant**

00883838001  
883838-1

00-883838-001

8838381

## Boites à bornes

**439982**

**Boite à bornes 6 pôles pour câble 6 mmq avec ponts installés**  
capacité 450V 40A T<sub>min-max</sub> -5 / +150°C;  
cosse 6,3x0,8 mm

00774055001  
00-774055-1-000  
774055-1

00-774055-001  
00774055-1000

00-774055-1  
7740551

**Pressostats**

**376465**



**Pressostat 1 niveau 0÷50 mbar 0,5÷3,5 VDC**  
IN 5Vdc; Pmax 200mbar; mod. AM900/AMS900/FP/FXN/FXS/GXS/FPS/GPS

00775866002      00-775866-002      7758662  
775866-2

**398162**



**Pressostat 1 niveau 0÷50 mbar 0,5÷3,5 VDC**  
Pmax 200 mbar

00775866202      00-775866-202      01539157501  
01-539157-501      775866202      775866-202

**305962**



**Pressostat 1 niveau 35/17 mbar**  
contact capacité 16A 250V; Tmax 85°C

139321521      E224004

**451289**



**Pressostat 1 niveau 90/56 mbar**  
contact capacité 16A 250V; Tmax 85°C

E224005

**312108**



**Pressostat 1 niveau 180/70 mbar**  
contact capacité 16A 250V; Tmax 85°C

E926049

**376305**



**Pressostat Ø 84mm 80/60 - 35/20mbar**

00-231981-002      00231981006      00-231981-006  
2319812      231981-2      2319816  
231981-6

**376301**



**Pressostat Ø 84mm 125/105 - 57/42 - 40/25mbar**

00378758004      00-378758-004      3787584  
378758-4

**376302**



**Pressostat 3 niveau Ø 84 mm 40/25 92/77 160/140 mbar**

00378758005      00-378758-005      3787585  
378758-5

**376300**



**Pressostat 3 niveau Ø 80 mm 125/105 - 57/42 - 40/25 mbar**

00-378760-001      00378760003      00-378760-003  
3787601      378760-1      3787603  
378760-3



**Ventilateurs**

**392366**



**Ventilateur 18W 24Vdc 0,75A**

01240261001      01-240261-001      012402611  
01-240261-1

**392364**



**Bayonet nut**

01240267001      01-240267-001      012402671  
01-240267-1

**382695**



**Raccord à T**

filetée 1/2" x 23mm, raccord Ø 22x80 mm; joint  
Ø 24x37x1,6 mm

00886606000      00-886606-000      886606

**Fusibles, Condensateurs, Filtres RFI**

**311818**



**Condensateur de mise en phase 4µF  
450V 50/60Hz**  
Ø 30x71 mm; avec vis M8 et ecrou

00226568002      00-226568-002      2265682  
226568-2

**418004**



**Condensateur de mise en phase 5µF  
400V 50/60Hz**  
Ø 30x51 mm; avec vis M8

00226568009      00-226568-009      2265689  
226568-9

**332311**



**Condensateur de mise en phase 10 µF  
400/450V 50/60Hz**  
Ø 30x71 mm; ecrou M8

00226568010      00-226568-010      22656810  
226568-10

**344792**



**Condensateur de mise en phase 16µF  
450V 50/60Hz**  
Ø 30x71 mm; avec vis M8

00226568013      00-226568-013      00-232210-001  
22656813      226568-13      2322101  
232210-1      E206004

**390145**



**Condensateur de mise en phase 8µF  
400V 50/60Hz**  
Ø 30x82 mm; avec vis M8

00139321009      00-139321-009      00-226568-014  
00226568017      00-226568-017      00844956000  
00-844956-000      139321-9      22656814  
226568-14      844956

**315350**



**Fusible Ø 5x20 mm 0,50A 250V rapidee**

00785539027      00-785539-027      69561511  
695615-11      78553927      785539-27

**Fusibles, Condensateurs, Filtres RFI**

**435516**



Fusible Ø 5x20 mm 0,25A 250V retardé

00300099003      00-300099-003      300099-03  
3000993      300099-3

**312599**



Fusible Ø 5x20 mm 1A 250V retardé

00785539070      00-785539-070      6956152  
695615-2      78553970      785539-70

**397484**



Fusible Ø 5x20 mm 1,6A 250V retardé

00695615003      00-695615-003      00785539072  
00-785539-072      6956153      695615-3  
785539-072      78553972      785539-72

**451463**



Fusible Ø 5x20 mm 4A retardé

E228010

**320007**



Fusible Ø 5x20 mm 6,3A 250V retardé (10 pz)

00785539078      00-785539-078      78553978  
785539-78

**376162**



Fusible Ø 6,3x32 mm 0,8A 250V rapidee

00775570002      00-775570-002      7755702  
775570-2

**376163**



Fusible Ø 6,3x32 mm 6,3A 250V rapidee

00-152480-022      00775570001      00-775570-001  
15248022      152480-22      7755701  
775570-1

**393748**



Fusible 250mA 250V retardé

0091478200009      00-914782-00009      00914782009  
00-914782-009

**Pompes**

**394422**



Pompe de vidange 1P 45W 220/240V 50Hz  
aspiration Ø 35 mm; sortie Ø 30 mm; faston  
6,3

01297707002      01-297707-002

**376279**



Pompe de vidange 80W 220-240V 50Hz  
aspiration Ø 24 mm; sortie Ø 24 mm; faston P5

00-165653-001      00-699736-052      00-883527-001  
00883993001      00-883993-001      1656531  
165653-1      699736052      699736-052  
8835271      883527-1      8839931  
883993-1

## Pompes

376281



**Pompe de vidange 80W 230-240V/50Hz**  
aspiration Ø 24 mm; sortie Ø 24 mm

00883993012  
883993-12

00-883993-012

88399312

376286



**Pompe de vidange 1 phase 220W  
220-240V 1A 50Hz - SX**

aspiration Ø 28 mm; sortie Ø 26 mm; câble  
L=430 mm; câble L=615 mm; C=5µF 400V;  
AMX, AUXX

00324913001  
00-324913-1  
3249131V

00-324913-001  
3249131  
324913-1V

003249131  
324913-1

376293



**Pompe de lavage 1 phase 400W 230V  
50Hz**  
aspiration Ø 45 mm; sortie Ø 40 mm; 2800 rpm;  
câble L=460 mm; C=12,5µF 400V

00883833001  
883833-1

00-883833-001

8838331

409651



**Pompe de lavage 1 phase 720W 220-240V  
50Hz 3,2A**

aspiration Ø 60 mm; sortie Ø 50 mm; câble  
L=400 mm; C=16µF 425V

00883617001  
883617-1

00-883617-001

8836171

389351



**Pompe de lavage 1 phase 720W 220-240V  
50Hz**  
aspiration Ø 60 mm; sortie Ø 50 mm; 2800rpm;  
C=16µF 425V

01515765001

01-515765-001

376294



**Pompe de lavage 1 phase 730W 230-240V  
50Hz**

aspiration Ø 60 mm; sortie Ø 50 mm; câble  
L=420 mm; C=16µF/450V

00898253001  
898253-1

00-898253-001

8982531

403992



**Pompe de lavage 3 phases 1100W  
220-240/380-415V 50Hz**  
aspiration Ø 61 mm; sortie Ø 52 mm

00898108001  
898108-1

00-898108-001

8981081

389350



**Pompe de lavage 3 phases 1200W  
220-240/380-415V 50Hz**

aspiration Ø 62 mm; sortie Ø 2"; câble L=300  
mm

01515768001

01-515768-001

321576



**Pompe de lavage 3 phases 1200W 3,7A  
220-240/380-415V 50Hz**  
aspiration Øext 61,5 mm; sortie Øext 61 mm

00883525001  
883525-1

00-883525-001

8835251

382805



**Pompe de lavage 1 phase 550W 220-240V  
50Hz 3,8/3,48A**

câble L=630 mm

00-231936-001  
00-895499-000  
7755061

00-775506-001  
2319361  
775506-1

00895499000  
231936-1  
895499

**Pompes**

**316693**



**Pompe de lavage 1 phase 1100W 230V 50/60Hz 3,8A**  
 aspiration Øext 60 mm; sortie Øext 50 mm;  
 C=16 µF

139321 13947

**389253**



**Pompe de rinçage 1 phase 140W 220-240V 50Hz 0,6A**  
 aspiration Ø 28 mm; sortie Ø 26 mm; câble  
 L=105 mm; câble L=130 mm

01515260001 01-515260-001 015152601  
 01-515260-1

**398239**



**Pompe de rinçage 1 phase 140/160W 220-240V 50/60Hz - SX**  
 aspiration Ø 27,5 mm; sortie Ø 26 mm; turbine  
 en INOX

00-775854-002 00775854003 00-775854-003  
 775854-2 7758543 775854-3

**399751**



**Pompe de rinçage 1 phase 290W 220/240V 60Hz 1,4A**  
 aspiration Ø 28 mm sortie Ø 26 mm; C=5µF  
 400V; FTN

00324093023 00-324093-023 32409323  
 324093-23

**613978**



**Pompe de rinçage 1 phase 220W 230V 1,1A 50 Hz**  
 SAPIN 5213; aspiration Ø 30 mm; sortie Ø 26  
 mm; 2800 rpm; C=5 µF 400V  
 (Pour les machines electrolux avec n° de  
 série.<60800000 voir KIT 0L1640)

E929167

**376282**



**Pompe de rinçage 1 phase 100W 220-240V 50Hz 0.46A**  
 sortie Ø 26 mm; C=4µF 400V

00-775465-001 00897929000 00-897929-000  
 7754651 775465-1 897929

**376276**



**Pompe de rinçage 1 phase 140W 220-240V 0,6A 50Hz - SX**  
 aspiration Ø 28 mm; sortie Ø 26 mm; C=4µF  
 400V; AMX, AUXXL, ECOMAX  
 402-452-502-602-612, FX-FP

00775854001 00-775854-001 7758541  
 775854-1

**376277**



**Pompe de rinçage 1 phase 270W 220/240V 1,3A 50Hz SX**  
 aspiration Ø 28 mm sortie Ø 26 mm; C=5µF  
 400V

00-324093-021 32409321 324093-21  
 32409321V 324093-21V

**382818**



**Couvercle de pompe [KIT]**

00895447000 00-895447-000 01-245113-001  
 012451131 01-245113-1 895447

**387031**



**Couvercle de pompe Ø 323 mm**  
 sortie bride Ø 96 mm; vis fileté M10

00324683000 00-324683-000 324683

**Pompes**

**403403**



**Turbine Ø 103 mm**  
pour pompe 316692 - 316688

E124031

**378639**



**Service KIT - pour pompe de lavage**  
**378649**

00785440010	00-785440-010	00-883253-010
00-898116-010	78544010	785440-10
88325310	883253-10	89811610
898116-10		

**404078**



**Service KIT - pour pompe de lavage**  
turbine Ø 100 mm M7; O-ring 3.5x160 mm;  
avec palier

00898108010	00-898108-010	89810810
898108-10		

**376216**



**Service KIT - pour pompe type ZF220SX**  
**50Hz**

00883833010	00-883833-010	88383310
883833-10		

**404083**



**Service KIT - pour pompe de lavage**

00-883617-010	00898253010	00-898253-010
01515765010	01-515765-010	88361710
883617-10	89825310	898253-10

**376181**



**Service KIT**  
mod. AMX70/AUX70/FTN-SB/UX30/UX60

00-324815-004	00-324815-104	00895444000
00-895444-000	324815104	324815-104
3248154	324815-4	895444
ML74328		

**376166**



**Turbine Ø 90 mm H=32,5 mm - sens de**  
**rotation droite**

00231876001	00-231876-001	2318761
231876-1		

**390018**



**Joint pour pompe de lavage AMX**  
Ø 84xh23 mm

01515893002	01-515893-002
-------------	---------------

**389977**



**Joint pour pompe de lavage AMXX/AUXX**  
Ø 85xh24 mm

01515893001	01-515893-001
-------------	---------------

**406768**



**Protection plastique**  
dim. 170x260xh0,3 mm

00867014001	00-867014-001	8670141
867014-1		

**Pompes**

**389300**



**Support pompe**

01515154001      01-515154-001      015151541  
01-515154-1

**Résistances**

**318634**



**Résistance ECHFOIL 545W 220/240V**  
dim. 360x95 mm, câble L=1800 mm

00898126001      00-898126-001      00-898126-002  
89812601      8981261      898126-1  
8981262      898126-2

**376326**



**Résistance surchauffeur 2440W 254V**  
dim. 415x65 mm; bride 81x28 mm; faston 6,3x0,8 mm

00324644002      00-324644-002      3246442  
324644-2

**376337**



**Résistance surchauffeur 3000W 240V**  
dim. 350x80mm; avec sonde; faston 6.3x0.8 mm

00775464002      00-775464-002      7754642  
775464-2

**376339**



**Résistance surchauffeur 4880W 254V**  
L=420 mm

00324637002      00-324637-002      00324637102  
00-324637-102      324637-02      324637102  
324637-102      3246372      324637-2

**376348**



**Résistance surchauffeur 6100W 254V**  
dim. 80x460 mm; faston 6.3x0.8 mm

00324637003      00-324637-003      00324637103  
00-324637-103      324637103      324637-103  
3246373      324637-3

**376343**



**Résistance surchauffeur 6540W-240V**  
L=415 mm; bride 81x28 mm; faston 6,3 mm; avec joint

00324637001      00-324637-001      00324637101  
00-324637-101      324637-01      3246371  
324637-1      324637101      324637-101

**376344**



**Résistance surchauffeur 6000W 240V**  
dim. 82x350 mm; faston 6.3x0.8 mm

00775464001      00-775464-001      7754641  
775464-1

**316875**



**Résistance surchauffeur 6000W 240V**  
L=325 mm; triangulaire bride; avec decoupé pour bulbe Øint 5 mm, avec o-ring

01240761001      01-240761-001      01240761002  
01-240761-002      012407611      01-240761-1

## Résistances

**389254****Résistance surchauffeur 7260W 250V**

L=350 mm; triangulaire bride 83,5x79 mm; Øint 49,50; con guaina portabulbo L=225 mm; Faston 6,3

01515258001  
01-515258-1

01-515258-001

015152581

**378617****Résistance surchauffeur 7260W 250V**

L=380 mm; triangulaire bride; avec decoupé pour bulbe Ø 5 mm, avec O-ring

01-240135-001  
012401351  
01-240135-2

01240135002  
01-240135-1

01-240135-002  
012401352

**316839****Résistance surchauffeur 5500/6543W 220/380V [KIT]**

L=355 mm; triangulaire bride 72x72 - connexion M4 avec découpe pour bulbe Øint 7x175 mm

E230083

E230083C

**323472****Résistance surchauffeur 8000W 230V [KIT]**

L=365 mm; triangulaire bride H= 83 mm Øint.49 mm; avec découpe pour bulbe; connexion M4 joint torique

E230020

E230095

**319418****Résistance surchauffeur 9500W 230V**

L=335 mm; triangulaire bride 83,5x78,8 mm - connexion M4 avec découpe pour bulbe Øint 7,5 mm

E80398

**398242****Résistance cuve 3000W 240V**

dim. 210x120 mm; bride 50,3x26,70 mm; F6,3

00775853001  
775853-1

00-775853-001

7758531

**376338****Résistance cuve 3000W 254V**

dim 410x30x70 mm; bride 50x27 mm; faston 6,3x0,8 mm

00883423001  
883423-1

00-883423-001

8834231

**405840****Câble de connexion**

00227073029  
22707329

00-227073-029  
227073-29

227073-029  
ML102844

**397952****Bride avec joint 29x80,5 mm**

00774808001  
774808-1

00-774808-001

7748081

## Commutateurs, Régulateurs d'énergie

376068



**Commutateurs 0-4 positions**  
D-axe Ø 6x4,6 mm L=23 mm

00845259000

00-845259-000

845259

390808



**Commutateur 0-2 positions**  
16A 250V; D-axe Ø 6x4,6 mm

00231960005  
231960-5

00-231960-005

2319605

## Transformateurs

399434



**Transformateur 8VA 240V 50/60Hz**  
dim. 50x118 mm

00324870001  
3248701  
324870-400-324870-001  
324870-100-324870-004  
3248704

390229



**Transformateur 400W 50/60Hz**  
dim. 112x126x107 mm; PRI- 400-415-440V -  
SEC- 220/230V

00226211015  
226211-15

00-226211-015

22621115

397529



**Transformateur 440-200/220-240 630 VA**

00695543001  
695543100-695543-001  
695543-1

695543-001

## Câbles

382797



**Boîte de connexion [KIT]**  
dim. 90x90x35 mm

00-229513-002  
229513200896967000  
229513-200-896967-000  
896967

376298



**Passe-fils à vis M32 - câble Ø 21 mm**

00695661005  
695661-5

00-695661-005

6956615

385626



**Passe-fils Ø 12,5x20,5x7 mm**

00064824

00-064824

64824

376310



**Pass-fil Ø 29x41 mm**

00886756003  
886756-3

00-886756-003

8867563



**Thermostats**

**400320**



**Thermostat à contact**  
à réarmement manuel; 16A 250V

0029461500001    00-294615-00001    2946151  
294615-1

**386420**



**Thermostat à contact Klixon**  
à réarmement manuel; 16A 250V

00294618    00-294618    294618

**387856**



**Thermostat à contact de sécurité**  
dim. 51x38x25 mm; câble L=260 mm; sonde  
L=500 mm

00271123    00-271123    271123

**318112**



**Thermostat à contact 95°C 1P**

E236047    E926189

**376451**



**Thermostat à contact de sécurité 105°C  
1NC 1P**  
Ø 15,8 mm; faston 6,3x0,8 mm

226504

**383428**



**Thermostat d'utilisation 1P 85°C**  
capillaire revêtu L=1150 mm; bulbe Ø 4x200  
mm; axe Ø 6x3,3 mm; faston 6,3x0,8 mm

00-226505-004    00897927000    00-897927-000  
226505004    2265054    226505-4  
897927

**376458**



**Thermostat d'utilisation 1P 95°C**  
capillaire revêtu L=1180 mm; bulbe Ø 4x220  
mm; 16A 250V

00-226505-000    00886638000    00-886638-000  
226505    886638

**400373**



**Thermostat d'utilisation 1P 86÷266°F**  
capillaire L=1200 mm; bulbe Ø 13x130 mm;  
presse étoupe M17

002946810312    00-294681-031-2    294681312  
294681-31-2

**317003**



**Thermostat de sécurité 1P 83°C**  
capillaire L=3150 mm; bulbe Ø 6x95 mm

00139321019    00-139321-019    00-139321-398  
13932119    139321-19    139321398  
139321-398    E236043

**387852**



**Thermostat de sécurité**  
capillaire L=500 mm; bulbe Ø 6,4x106 mm;  
presse étoupe M17

00274160    00-274160    274160

**Thermostats****387851****Thermostat d'utilisation**

capillaire L=500 mm; bulbe Ø 6,4x112 mm;  
presse étoupe M17

00274161

00-274161

274161

**387713****Presse-étoupe M12x1 [KIT]**

00227024000

00-227024-000

227024

**Groupe de lavage**

**319751**



**Bras de lavage L=515 mm**  
AMX, AUX, AUP, AM900

00883454001      00-883454-001      8834541  
883454-1

**318954**



**Bras de lavage L=510 mm**  
moyeu Ø 17 mm - ECOMAX 502, AM10 / AM11 / AM141, FX/GX & FP/GP

01240050001      01-240050-001      012400501  
01-240050-1

**389412**



**Bras de lavage L=515 mm [Kit]**  
PROFI AMX - PROFI AMXX / PROFI AM900 / PREMAX AUP

01515575001      01-515575-001

**376048**



**Bras de lavage L=512 mm**  
AM700, AM900 / AMS900, ECOMAX 600

00-324039-000      00-324444-000      00-324444-001  
00883472001      00-883472-001      324039  
324444      3244441      324444-1  
8834721      883472-1

**389408**



**Bras de lavage L=535 mm [Kit]**  
PROFI AMXXL / PREMAX AUPL, PROFI AMX  
PROFI AMXX / PROFI AM900 / PREMAX AUP

01515588001      01-515588-001

**409493**



**Bras de lavage 535x535 mm**  
AMX / AUX, AMXXT Serie / AUXXT Serie,  
AUXXL Serie

00-324614-000      00-324798-001      00883453001  
00-883453-001      324614      3247981  
324798-1      8834531      883453-1

**409491**



**Bras de lavage 535x535 mm**  
AMX - AMXX / AUXX - AUP, AMXT - AMXTS /  
AUXXT - AUXXTS, AUXXL-11N /  
AUXXLS-11N

00883460001      00-883460-001      8834601  
883460-1

**319752**



**Bras de rinçage [KIT]**  
AMX, AUXX, AUP

01240096004      01-240096-004      012400964  
01-240096-4

**376055**



**Bras de rinçage L=515 mm**  
AM10 / AM11 / AM141, AMX - AMXX / AUXX -  
AUP, ECOMAX 502, FX/GX & FP/GP, UXT /  
UPT

01-240084-003      012400843      01-240084-3  
01240096003      01-240096-003      012400963  
01-240096-3

**388475**



**Bras de rinçage L=520 mm avec Clip-in**  
PROFI AMXXL / PREMAX AUPL, PROFI AMX  
PROFI AMXX / PROFI AM900 / PREMAX AUP,  
PROFI FX-FXL-FXL-GX / PREMAX FP-GP

01515843001      01-515843-001      01539620001  
01-539620-001

**Groupe de lavage**

**376056**



**Bras de rinçage L=520 mm**  
raccord M1/4" - AM900 / AMS900, AMX900, AMXXT Serie / AUXXT Serie, FX/GX SERIE

00324052000	00-324052-000	00-324445-000
01-240084-002	012400842	01-240084-2
01240096002	01-240096-002	012400962
01-240096-2	324052	324445

**455391**



**Axe support jet Ø 11 mm - L=52,5 mm**  
filetée M12; CH14

E80283

**409472**



**Axe support jet Ø 17 mm - L=75,5 mm**

00883500002	00-883500-002	8835002
883500-2		

**376269**



**Axe support jet Ø 16 mm - L=60 mm**

00324040000	00-324040-000	324040
-------------	---------------	--------

**409495**



**Axe support jet Ø 17 mm - L=61 mm**

00883479001	00-883479-001	8834791
883479-1		

**376475**



**Axe support jet Ø 17 mm - L=69 mm**

00883479002	00-883479-002	8834792
883479-2		

**382859**



**Axe support jet Ø 19 mm - L=47 mm**

00893052	00-893052	893052
----------	-----------	--------

**376406**



**Support bras lavage supérieur**  
Øint./est. 53/62 mm; axe Øest. 16x59 mm

00-324670-000	00886607000	00-886607-000
324670	886607	

**385195**



**Support bras lavage inférieur**

00172694000	00-172694-000	172694
-------------	---------------	--------

**385150**



**Support bras lavage supérieur**  
axe pour support Ø 19x52,60 mm

00172695000	00-172695-000	172695
-------------	---------------	--------

**Groupe de lavage**

**376402**



**Support bras lavage inférieur**

00898194001      00-898194-001      8981941  
898194-1

**376401**



**Support bras lavage inférieur**

raccord cannelé Ø 14 mm, Ø 47 mm, Ø 57,5 mm

00883488001      00-883488-001      8834881  
883488-1

**376403**



**Support bras lavage [Kit]**

00-324268-000      00324480000      00-324480-000  
324268      324480

**455357**



**Support bras lavage inférieur**

filée M10 - raccord cannelé Ø 11,35 mm

E80179

**409488**



**Support bras lavage supérieur**

00883466001      00-883466-001      8834661  
883466-1

**376404**



**Support bras lavage supérieur**

00883467001      00-883467-001      8834671  
883467-1

**393841**



**Support bras de lavage**

00-893033      00948668      00-948668  
00948668000      00-948668-000      893033

**450791**



**Support bras lavage Øint. 102/est. 140 mm**

tuyau; 1 x Øest. 50 mm, 1 x Øest. 60 mm

E136020

**455355**



**Support bras de lavage supérieur L=310 mm**

E80177

**392680**



**Bouchon jet de rinçage Ø 23,5x28xH28 mm**

01245080001      01-245080-001      012450801  
01-245080-1

**Groupe de lavage**

**318191**

**Bouchon [4 pcs]**



00-324172-000    00867429001    00-867429-001  
 00886609000    00-886609-000    324172  
 8674291    867429-1    886609

**376490**

**Bouchon Ø 22 mm**



01240028001    01-240028-001    012400281  
 01-240028-1

**382678**

**Bouchon pour bras de lavage [4 pcs]**  
 Ø 28x10 mm; M23



00-324785-000    00886610000    00-886610-000  
 324785    886610

**376414**

**Bouchon pour bras de rinçage**  
 Ø 16x11 mm



00226816000    00-226816-000    226816

**392681**

**Bouchon bras de rinçage Ø 24,5 mm**



01245080002    01-245080-002

**339694**

**Injecteur bras de lavage, LTB**



139321-31    139321-32    E140008

**376491**

**Injecteur bras de rinçage**  
 H=21,5 mm



00226800001    00-226800-001    2268001  
 226800-1

**376270**

**Tige bras de rinçage**  
 écrou CH32, Ltot.=31,5 mm



00324067000    00-324067-000    324067

**317702**

**Injecteur bras de rinçage Ø 2,5 mm**



139321-952    E140025

**404131**

**Bride 205x40x18 mm**



00898278001    00-898278-001    8982781  
 898278-1

**Groupe de lavage**

**376066**



Raccord Ø 23 mm - Ltot=55 mm

01240159001    01-240159-001    012401591  
01-240159-1

**386898**



Raccord 90° sortie Ø 18 mm

00324097000    00-324097-000    324097

**398474**



Agrafe de tuyau Ø 26xh10 mm

00775512001    00-775512-001    7755121  
775512-1

**376040**



Bague Ø 14 mm - H=21 mm  
Øint 8 mm

00228643000    00-228643-000    228643

**376090**



Bague bras de lavage avec écrou Ø 24 mm - H=58 mm

00-324727-000    00734804001    00-734804-001  
324727    734804001    7348041  
734804-1

**409584**



Bague bras de lavage avec écrou Ø 22 mm - H=37,4 mm

00-883452-001    00883974001    00-883974-001  
8834521    883452-1    8839741  
883974-1

**376088**



Bague bras de lavage avec écrou Ø 22 mm - H=39 mm  
CH30

00734803001    00-734803-001    7348031  
734803-1

**376038**



Bague bras de lavage avec écrou Ø 22 mm - H=56 mm

00-883452-002    00-883974-002    01-510677-001  
015106771    01-510677-1    01-510678-001  
015106781    01-510678-1    01510702001  
01-510702-001    015107021    01-510702-1  
8834522    883452-2    8839742  
883974-2

**388472**



Bague bras de lavage avec écrou Ø 23,10 mm - H=42,84 mm

01515586001    01-515586-001    01539624002  
01-539624-002

**388473**



Bague bras de lavage avec écrou Ø 22,70 mm - H=36,63 mm

01515579001    01-515579-001    015155791  
01539624001    01-539624-001    01-539624-1

**Groupe de lavage**

**376097**



**Ecrou support bras de lavage**  
Ø 11,7x32x3 mm

00231893001      00-231893-001      2318931  
231893-1

**376101**



**Ecrou support bras de lavage**  
Ø 53.2x74x44,5 mm; CH 65 mm

00324698001      00-324698-001      3246981  
324698-1

**376102**



**Ecrou Ø 34,5x7,5 mm**  
CH 30 mm

00324384000      00-324384-000      324384

**376100**



**Ecrou support bras de lavage Ø 74 mm**

00883496001      00-883496-001      8834961  
883496-1

**409476**



**Ecrou Øint52.60 mm H=34,60 mm**

00883497001      00-883497-001      8834971  
883497-1

**387026**



**Anneau plastique Ø 50x33,5/37,3x5,5 mm**

00324729000      00-324729-000      324729

**395083**

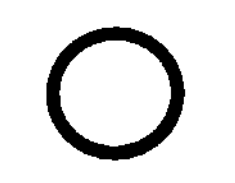

**Joint plane Ø 56x64x1,4 mm**

01245460001      01-245460-001      012454601  
01-245460-1

**376021**



**Anneau TEFLON Ø 13x24x1 mm**

00774072007      00-774072-007      7740727  
774072-7

**376268**



**Tige de bras de rinçage**

01240095001      01-240095-001      012400951  
01-240095-1

**452765**



**Joint Ø 40x44x3 mm**

E303032



## Vanne de vidange

**399687**

**Vanne de vidange 180° - 1 voie - 240V  
50Hz**  
entrée Ø 17 mm; sortie Ø 20 mm; F6.3x0.8 mm  
- eau chaude

00323785002	00-323785-002	00323785012
00-323785-012	32378512	323785-12
3237852	323785-2	

**376116**

**Vanne de vidange 180° - 1 voie - 230V  
50Hz 0,5bar**  
entrée Ø 17 mm; sortie Ø 20 mm - eau chaude

00-323785-001	00323785011	00-323785-011
3237851	323785-1	32378511
323785-11		

**406573**

**Joint vanne de vidange [Kit]**  
Joint torique 2,62x45,69 mm; joint Ø 29 mm

ML75068

## Chambres air

**339960**

**Raccord en T Ø 8,4x20xh14 mm**  
raccord cannelé Ø 5 mm

00-139321-180	00-139321-202	139321-180
139321202	139321-202	897923

**387058**

**Écrou chambre de compression**  
H=20 mm

00324183000	00-324183-000	324183
-------------	---------------	--------

**389393**

**Chambre de compression [KIT]**  
dim. 205x145 mm; portagomma Ø 10,50 mm

01515331002	01-515331-002	015153312
01-515331-2		

**389394**

**Chambre de compression [KIT]**  
dim. 205x145 mm; embout tuyau Ø 10,50 mm

01515331001	01-515331-001	015153311
01-515331-1		

**376496**

**Chambre de compression [KIT]**  
mod. ECOMAX avec adoucisseur

00775540001	00-775540-001	00-895457-000
01297510001	01-297510-001	01-297510-002
012975101	01-297510-1	012975102
01-297510-2	01297695001	01-297695-001
012976951	01-297695-1	7755401
775540-1	895457	

**376500**

**Chambre de compression**  
embout tuyau Ø 13 mm; mod. ECOMAX 602-1C  
sans adoucisseur

00775759001	00-775759-001	7757591
775759-1		

**Chambres air**

**315746**



**Chambre de compression 84x81x42mm**  
avec raccord, collier de serrage bifilaire, joint torique et vis

00139321047      00-139321-047      13932147  
139321-47

**382024**



**Chambre de compression 65x80x17 mm [KIT]**  
embout tuyau Ø 5 mm

00324858000      00-324858-000      324858

**376462**



**Chambre de compression [Kit]**  
O-ring Ø 3x24 mm

01240372001      01-240372-001      012403721  
01-240372-1      01-246204-001      012462041  
01-246204-1

**389405**



**Chambre de compression [KIT]**  
embout tuyau Ø 6,3 mm

01-515236-001      015152361      01-515236-1  
01515334001      01-515334-001      015153341  
01-515334-1

**389377**



**Connexion chambre de compression**  
embout tuyau Ø 10,50 mm

01515134001      01-515134-001      015151341  
01-515134-1      01515332001      01-515332-001  
015153321      01-515332-1

**376497**



**Chambre de compression [KIT]**  
dim. 625x140x35 mm

00886641000      00-886641-000      886641

**Doseurs, Doseur péristaltique**

**361240**



**Doseur hydraulique de rinçage débit réglable 1÷5 cc.**  
mod. DIB-5E; connection EV-surchauffeur - IN 180° et OUT 180° pour tuyau de Ø 4x6 mm

E209025

**376104**



**Doseur péristaltique rinçage débit fixe (U. interne)**  
mod. NPG-0,4; débit fixe 0,4 L/h; 1 bar; 230V 50Hz; câble L=470 mm; tuyau en sekobril

00883828001      00-883828-001      8838281  
883828-1

**383426**



**Doseur péristaltique rinçage débit fixe (U. interne)**  
mod. PG-0,4; débit fixe 0,4 L/h; 1 bar; 230V 50/60Hz; câble L=430 mm; tuyau en sekobril; protection 197x124x0,15 mm PVC

00-775556-001      00897930000      00-897930-000  
7755561      775556-1      897930

## Doseurs, Doseur péristaltique

**409556**

**Doseur péristaltique rinçage débit fixe (U. interne)**  
 mod. NPG-1,6; débit fixe 1,6 L/h; 1 bar; 230V 8W 50/60Hz; tuyau en sekobrill avec raccord embont Ø 5 mm; câble L=470 mm

00883828006  
883828-6

00-883828-006

8838286

**389243**

**Doseur péristaltique rinçage débit fixe (U. interne)**  
 mod. NPG-1,6; débit fixe 1,6 L/h; 1 bar; 230V 8W 50/60Hz; câble L=340 mm; tuyau en sekobrill

01-515269-001  
015152691  
01-515269-601515269006  
01-515269-101-515269-006  
015152696**389247**

**Doseur péristaltique rinçage débit fixe (U. interne)**  
 230V 50/60Hz 4,9/5,4W

01515268001  
01-515268-1

01-515268-001

015152681

**409605**

**Doseur péristaltique rinçage (U. interne)**  
 DSP 9911/03-AH; 4,9W 230V 50/60Hz

00883860001  
883860-1

00-883860-001

8838601

**376110**

**Doseur péristaltique lavage débit fixe (U. interne)**  
 mod. PG-3; débit fixe 3 L/h; 0,1 bar; 230V 50Hz câble L=480 mm; tuyau en Santoprene

00883828002  
883828-2

00-883828-002

8838282

**383425**

**Doseur péristaltique lavage débit fixe (U. interne)**  
 mod. PG-3; débit fixe 3 L/h; 0,1 bar; 230V 50Hz; câble L=470 mm; tuyau en Santoprene; protection 197x124x0,15 mm PVC

00-775556-002  
775556200897931000  
775556-200-897931-000  
897931**406539**

**Doseur péristaltique lavage débit fixe [KIT]**  
 mod. PG-3; débit fixe 3 L/h; 0,1 bar; 230V 50Hz; câble L=470 mm; tuyau en Santoprene; protection 197x124x0,15 mm PVC

ML71561ED

ML71561-ED

**700431**

**Doseur péristaltique lavage débit réglable (U. interne)**  
 mod. PBR-3; réglage débit 0,3+3 lt/h 0,1 bar; 230V 50Hz; câble L=200 mm; cpl. Kit d'installation

E209016

**409604**

**Doseur péristaltique lavage**  
 230V 50/60Hz 4,9/5,4W; câble L= 620 mm

00883860002  
883860-2

00-883860-002

8838602

**389259**

**Doseur péristaltique lavage 230V 50/60Hz 4,9/5,4W**  
 raccord embont Ø 4,6 mm; câble L=350 mm

01515268002  
01-515268-2

01-515268-002

015152682

**Doseurs, Doseur péristaltique**

**410181**



**Tuyau doseur rinçage sekob Brill**  
L=175 mm - raccord Ø 4x6 mm

00775608001 00-775608-001 7756081  
775608-1

**410180**

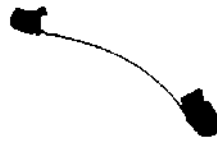

**Tuyau doseur lavage Santoprène Ø 6,25x10,55 mm**  
L=180 mm - raccord Ø 4x6 mm

00775608002 00-775608-002 775608-02  
7756082 775608-2

**398105**



**Tuyau doseur rinçage sekob Brill**  
Ø 6,25x10,55 mm - L=180 mm - raccord Ø 4x6 mm

00775608003 00-775608-003 7756083  
775608-3

**392406**



**Tuyau doseur rinçage**  
Øest. 6,5 mm, raccord Ø 4/4,5 mm

00-883860-011 01240195011 01-240195-011  
0124019511 01-240195-11 01515268011  
01-515268-011 0151526811 01-515268-11  
88386011 883860-11

**392477**



**Tuyau doseur lavage**  
Øest. 8 mm; raccord Ø 4/4,5 mm

00-883860-012 01240195012 01-240195-012  
0124019512 01-240195-12 01515268012  
01-515268-012 0151526812 01-515268-12  
88386012 883860-12

**365039**



**Tuyau en PVC Ø 4x6 mm (vendu au mètre)**

00-324402-000 00-324402-099 00-493424-000  
00-898252002 00-898252-002 01246301008  
01-246301008 01-246301-008 01246301016  
01-246301-016 0124630108 01-24630108  
01-246301-08 01246301099 01-246301-099  
0124630116 01-246301-16 012463018  
01-2463018 01-246301-8 01-246301-99  
01515410002 01-515410-002 01-515410-008  
01515410016 01-515410-016 01515410099  
01-515410-099 01-515410-2 324402  
32440299 324402-99 493424  
775601 8982522 898252-2

**399464**



**Tuyau en PVC Ø 4x7x1640 mm**

00324402002 00-324402-002 3244022  
324402-2

**200253**



**Tuyau en PVC transparent Ø 4x6 mm L=2660 mm**

00898252003 00-898252-003 00898252005  
00-898252-005 01-246301-010 0124630110  
01-24630110 01-246301-10 01515410010  
01-515410-010 01-51541010 01-515410-10  
8982523 898252-3 8982525

**Doseurs, Doseur péristaltique**

**410462**



Tuyau en PVC transparent Ø 4x6 mm  
L=4000 mm

01-246145-001	012461451	01-246145-1
01246301001	01-246301-001	01246301011
01-246301011	01-246301-011	012463011
01-246301-1	0124630111	01-246301-11
01515410001	01-515410-001	01-515410-011
12463011	15154101	

**339721**



Tuyau en PVC vert Ø 4x7 mm [vendu au mètre]

139321-200	3244025	E143013
------------	---------	---------

**376231**



Tuyau PE bleu Ø 8x10x40 mm

01246210001	01-246210-001	012462101
01-246210-1		

**410373**



Filtre d'aspiration in inox pour tuyau Ø 4x6 mm

00775239001	00-775239-001	775239-01
7752391	775239-1	E121075

**376152**



Filtre d'aspiration in inox pour tuyau Ø 6 mm

00-227441-000	00227441001	00-227441-001
227441	2274411	227441-1

**376316**



Raccord 1/8" - L=44 mm  
pour tuyau Ø 5 mm

01240452001	01-240452-001	012404521
01-240452-1		

**394393**



Raccord en T Ø 11-6-11 mm

01-297803-001	012978031	01-297803-1
01297816001	01-297816-001	012978161
01-297816-1		

**376095**



Ecrou M9x1  
pour tuayu Ø 6 mm

00775507001	00-775507-001	7755071
775507-1		

**376312**



Raccord Ø 5 mm [KIT]  
filetée M10

00883676001	00-883676-001	00-883676-002
8836761	883676-1	8836762
883676-2		

**311413**



Raccord 90° M12 mm inox  
pour tuyau Ø 4x6 mm

E468151

## Doseurs, Doseur péristaltique

387042



**Injecteur Ø 3 mm Ltot=33 mm**  
fileté M10x1

00324249000

00-324249-000

324249

## Electrovannes et Réducteurs

376126



**Electrovanne 180° - 1 voie - 230V 50/60Hz - Ø 10,5 mm**  
avec fastons; entrée Ø 3/4" avec filtre et entrée réducteur 5lt/min ; Tmax 90° C (RPE)

00883658001

00-883658-001

01-246164-001

012461641

01-246164-1

8836581

883658-1

376113



**Electrovanne 180° - 1 voie - 220/240V 50/60Hz - Ø 10,5 mm**  
avec fastons; entrée Ø 3/4" avec filtre et entrée réducteur 15lt/min ; Tmax 90° C (RPE)

00883658002

00-883658-002

01-246164-003

012461643

01-246164-3

8836582

883658-2

390738



**Electrovanne en laiton G3/4" 110/120V 50/60Hz**  
bobine 9W 110/120V 50/60Hz

0027100200001  
271002-1

00-271002-00001

2710021

376121



**Electrovanne en laiton NC 1/2" - 10,5W 230V 50Hz**  
L=70 mm; bobine 220/230V 50Hz 10,5W

00173863000

00-173863-000

173863

390547



**Bobine 10,5W 220/230V 50Hz**

00173863012  
173863-12

00-173863-012

17386312

388975



**Electrovanne en laiton G1/2" 220/240V 50/60Hz**  
L=95 mm; bobine 220/240V 50/60Hz 9,6W; membrane in PFTE; Psteam 2-50 PSI

0011209100002  
112091-2

00-112091-00002

1120912

382843



**Bobine 11W 110/120V 50/60Hz**

00892132

00-892132

892132

398467



**Bobine 230V 50/60Hz**  
pour electrovanne 376114

00775530301  
775530-301

00-775530-301

775530301

**Electrovannes et Réducteurs**

**376200**



**Service KIT**  
pour electrovalve 376121

00173863011      00-173863-011      17386311  
173863-11

**582098**



**Service KIT**  
pour electrovalve 388974 en 388975

00-114299      114299

**376114**



**Electrovalve 180° - 1 voie - 220/240V**  
**50/60Hz - Ø 10 mm**  
avec fastons; entrée/sortie Ø 10 mm

00775897001      00-775897-001      7758971  
775897-1

**Vannes sphériques, Raccords**

**401009**



**Raccord cannelé 90° - G1/2"**

00299240001      00-299240-001      2992401  
299240-1

**390362**



**Raccord cannelé G1/8" - sortie Ø 5,50 mm**

00227249001      00-227249-001      00-227249-003  
2272491      227249-1      2272493  
227249-3

**376308**



**Raccord 90° Øest. 18 mm**

00883281001      00-883281-001      8832811  
883281-1

**376307**



**Raccord en T Ø 17,5 - 13,5 - 13,5 mm**  
dim. 80x40 mm

00324071000      00-324071-000      00-324071-001  
324071      324071-1

**390600**



**Raccord à Y Ø 10-10-10 mm**

00174047002      00-174047-002      1740472  
174047-2

**450850**



**Raccord en Y Ø 12-12-12 mm**

E143173

**Vannes sphériques, Raccords**

**390992**



**Tuyau de connexion Øint. 50x105 mm**

00229680001      00-229680-001      2296801  
229680-1

**376498**



**Valve anti-réflux Ø 19 mm - L=100 mm  
embout cannelé Ø 10 mm**

01240142001      01-240142-001      012401421  
01-240142-1      01-240144-001      012401441  
01-240144-1      01-240145-001      012401451  
01-240145-1

**389641**



**Valve anti-réflux Ø 22 mm - L=100 mm  
embout cannelé Ø 10 mm**

01515775001      01-515775-001

**376499**



**Valve anti-réflux L=100 mm**

00883817001      00-883817-001      8838171  
883817-1

**389518**



**Valve anti-réflux [KIT]  
embout cannelé Ø 10,50; entrée/sortie Ø 22 mm**

00883817002      00-883817-002      01-510300-001  
01510300002      01-510300-002      015103001  
01-510300-1      01510300-1      015103002  
01-510300-2      01-51031      01-510552-001  
01510552002      01-510552-002      015105521  
01-510552-1      015105522      01-510552-2  
8838172      883817-2

**376417**



**Bouchon Ø 10 mm**

00775531001      00-775531-001      7755311  
775531-1

**400346**



**Valve anti-réflux 1/2" FF 180°F/125PSI**

0029290900002      00-292909-00002      2929092  
292909-2

**386479**



**Valve anti-réflux 1/2" FF 180°F/125psi**

00-146669-001      00292909      00-292909  
1466691      146669-1      292909



**Tuyaux**

**376483**

**Tuyau formé L=705 mm**  
raccords Ø 16,5x23 mm - Ø 25x30 mm



00883721001 00-883721-001 8837211  
883721-1

**407686**

**Tuyau formé Ø 30x38x84 mm**



00781335001 00-781335-001 7813351  
781335-1

**382800**

**Tuyau formé [Kit]**  
raccords 45° Ø 30x38x84 mm; raccords 90° Ø 30x38 mm dim. 100x100 mm; agrafe de tuyau Ø 35-40 mm



00-781336-001 00896964000 00-896964-000  
7813361 781336-1 896964

**382021**

**Tuyau formé Ø 26x32 mm**  
dim. 165x100 mm



00324867000 00-324867-000 324867

**399445**

**Tuyau formé Ø 15x22 mm / Ø 25x32 mm - L=492 mm**



00324772001 00-324772-001 3247721  
324772-1

**409506**

**Manchon Ø 26x32,5x40 mm**



00883145003 00-883145-003 00-883145-007  
8831453 883145-3 8831457  
883145-7

**319738**

**Tuyau formé 90° Ø 30 mm L=270 mm**



00898177001 00-898177-001 8981771  
898177-1

**404173**

**Tuyau formé 90° Ø 15x22,5 mm**  
dim. 42x290 mm; Ø 13x20 mm



00898233001 00-898233-001 8982331  
898233-1

**582855**

**Tuyau formé 90°**



01245307001 01-245307001 01-245307-001  
012453071 01-245307-1

**394440**

**Tuyau formé Ø 10x18 mm**  
dim. 44x34 mm



01297689001 01-297689-001 012976891  
01-297689-1

**Tuyaux**

**404145**



**Tuyau formé 90° Ø 60x74 mm**  
dim. 335x115 mm

00898176001    00-898176-001    00-898176-002  
8981761    898176-1    8981762  
898176-2

**404146**



**Tuyau formé 90° Ø 38x49 mm / Ø 49x60 mm**  
dim. 180x165 mm

00898175001    00-898175-001    8981751  
898175-1

**324780**



**Tuyau formé Ø 40/48x80 mm**

E127082

**387128**



**Tuyau formé**  
dim. 180x130x30 mm; M24; CH 30

00300707000    00-300707-000    300707

**200005**



**Tuyau en EPDM Ø 5x12 mm (vendu au mètre)**

E143005

**402829**



**Tuyau en EPDM Ø 5x12 mm L=1000 mm**

00-139321-127    00371450173    00-371450-173  
139321127    139321-127    371450173  
371450-173

**346280**



**Tuyau en EPDM Ø 10x17 mm - blu - (vendu au mètre)**  
Pmax 10 bar; Temp. de travail -35°C+110°C; homologué FDA

00-775559-000    00-775559-016    77555916  
775559    E143004

**398378**



**Tuyau EPDM Ø 10x17 mm L=505 mm**

00775559018    00-775559-018    77555918  
775559-18

**398398**



**Tuyau EPDM Ø 10x17 L=820 mm**

00775559012    00-775559-012    77555912  
775559-12

**200002**



**Tuyau en EPDM Ø 12x19,5 mm (vendu au mètre)**  
pour eau chaude - Pmax 10 bar - temp. de travail -35°C+120°C

E143010

**Tuyaux**

**404100**



Tuyau EPDM Ø 16x27 mm L=715 mm

00898248001	00-898248-001	00898248002
00-898248-002	8982481	898248-1
8982482	898248-2	

**376481**



Tuyau EPDM Ø 25,5x32,5x86 mm

00-883145-013	00883680001	00-883680-001
8836801	883680-1	

**376472**



Tuyau PE-Xb Ø 10x14x936 mm

00883512001	00-883512-001	01-297505-001
012975051	01-297505-1	8835121
883512-1		

**399463**



Tube Ø 4x7x2600 mm

00324402003	00-324402-003	3244023
324402-3		

**376469**



Tuyau en silicone Ø 10x15 mm L=1000 mm

00774080001	00-774080-001	7740801
774080-1		

**399747**



Tuyau en silicone Ø 85x89 mm L=700 mm

00324081001	00-324081-001	3240811
324081-1		

**399755**



Tuyau d'alimentation en caoutchouc 3/4" L=2000 mm  
ecrou en laiton Ø 3/4"F; DN13; avec filtre;  
temp. 90°C

00324088001	00-324088-001	3240881
324088-1		

**524404**



Tuyau d'alimentation recouvert d'acier 3/4" L=2000 mm DN13  
raccord droit + raccord coudé 90°; ecrou en laiton-nickel Ø 3/4"F; Pmax 25 bar; Tmax 100°C; certifié WRAS

012403161

**409539**



Tuyau d'alimentation Ø 23x1050 mm

00883167003	00-883167-003	8831673
883167-3		

**376219**



Kit tuyau d'alimentation  
tuyau flexible 3/4" 90°/180° L=1900 mm; tuyau EPDM Ø 10x16 mm L=1200 mm

00-775552-001	00-775552-002	00895495000
00-895495-000	00-898045-001	00-898045-004
01-246176-001	012461761	01-246176-1
01-246177-001	012461771	01-246177-1
7755521	775552-1	7755522
775552-2	895495	8980451
898045-1	8980454	898045-4

**Tuyaux**

**376485**



**Tuyau de vidange PPE Ø 19 mm 180° - Ø 19 mm 180° L=2100mm**  
raccords Øint./est. 19/25 mm; tuyau Øest. 25 mm

00324045000      00-324045-000      324045

**438247**



**Tuyau de vidange PPE Ø 21 mm 180°+ Ø 30 mm M 180° L=2150 mm**  
raccords Øint/ext 21/28 mm et 30/34 mm, tuyeau Øext 26,5 mm

00323801001      00-323801001      00-323801-001  
003238011      00-323801-1      3238011  
323801-1

**376484**



**Tuyau de vidange PPE Ø 22 mm 90° + Ø 19 mm 180° L = 2000 mm**  
manchon 180° Ø int/ext 19/25 mm, 90° ext Øint/manche 22/28 mm, 25 mm tube Øext

00371450111      00-371450-111      00883961001  
00-883961-001      00883961002      00-883961-002  
01-243347-001      012433471      01-243347-1  
371450111      371450-111      8839611  
883961-1      8839612      883961-2

**Traitement de l'eau**

**398468**



**Adoucisseur 220/240V 50/60Hz**  
dim. 210x230x205 mm

00-775530-001      00775530002      00-775530-002  
7755301      775530-1      7755302  
775530-2

**376082**



**Couvercle adoucisseur [KIT]**

00775530050      00-775530-050      77553050  
775530-50

**389584**



**Couvercle adoucisseur Ø 85,60 mm [KIT]**

01515030050      01-515030-050      0151503050  
01-515030-50

**376080**



**Couvercle adoucisseur [KIT]**  
joint Ø 55x72x3 mm

00-775918-050      00775918150      00-775918-150  
775918150      775918-150      77591850  
775918-50

**582130**



**Cartouche osmose inverse 1812 100GPD**  
avec 2 O-ring 2x14 mm

01294282101      01-294282-101

**459756**



**Cartouche carbone**  
H=275 mm

01-294225-001      012942251      01-294225-1  
01-294225-101      12942251      1294225101

**Composants de vidange**

**409643**



**Collecteur de vidange Ø 155 mm**

00883735001      00-883735-001      8837351  
883735-1

**404184**



**Collecteur de vidange Ø 155 mm**  
dim. 119x155x110 mm

00-898186-001      00898202001      00-898202001  
00-898202-001      00898202002      00-898202-002  
008982021      00-898202-1      8981861  
898186-1      8982021      898202-1  
8982022      898202-2

**392700**



**Collecteur de vidange**

01245109001      01-245109-001      012451091  
01-245109-1

**376158**



**Bride avec joint Ø 70x107 mm**

00-324053-000      00886639000      00-886639-000  
324053      886639

**376174**



**Joint Ø 80x100xH3,85 mm**

00324056000      00-324056-000      324056

**387700**



**Bonde de vidange Ø 1"1/2 H=35 mm**  
trou pour tuyau de trop-plein Ø 56/41 mm

00226558000      00-226558-000      226558

**390149**



**Bonde de vidange Ø 1" 1/2 H=20 mm**  
Øint. 41 mm

00226558001      00-226558-001      2265581  
226558-1

**392683**



**Bonde de vidange Øint. 45 mm - H=55,5 mm**

01245112001      01-245112-001      012451121  
01-245112-1

**409625**



**Tuyau de trop-plein avec filtre**  
Ltot.=300 mm; tuyau Ø 36 mm

00883550001      00-883550-001      8835501  
883550-1

**409610**



**Tuyau de trop-plein avec filtre Øext. 106 mm**  
Ltot.=245 mm; tuyau Øest. 35,5 mm

00883550002      00-883550-002      8835502  
883550-2

**Composants de vidange**

**399720**



**Tuyau de trop-plein avec filtre Ø 150 mm**  
Ltot.=460 mm; tuyau Øint.28/est. 36 mm

00323534001	00-323534-001	00-774412-001
00-774457-001	3235341	323534-1
324666	7744121	774412-1
7744571	774457-1	

**399645**



**Tuyau de trop-plein avec filtre Ø 154 mm**  
Ltot.=305 mm; tuyau Øint.28/est. 35 mm

00323534004	00-323534-004	3235344
323534-4		

**409623**



**Tuyau de trop-plein avec filtre Ø 155 mm**  
Ltot.=145 mm; tuyau Øest. 35,5 mm

00883550003	00-883550-003	8835503
883550-3		

**399688**



**Tuyau de trop-plein avec filtre Ø 155 mm**  
Ltot.=400 mm; tuyau Øint.28/est.36 mm

00323534003	00-323534-003	3235343
323534-3		

**319747**



**Tuyau de trop-plein Ø 35x318 mm**

00898185001	00-898185-001	8981851
898185-1		

**376489**



**Tuyau de trop-plein Ø 32x275 mm**

00883737001	00-883737-001	8837371
883737-1		

**382855**



**Tuyau de trop-plein Ø 50x435 mm**

00893071	00-893071	893071
----------	-----------	--------

**389175**



**Tuyau de trop-plein Ø 51x370 mm**

0011909900002	00-119099-00002	1190992
119099-2		

**459776**



**Couverture tuyau de trop-plein Ø 140 mm**

00-893072	00-893072-000	893072
-----------	---------------	--------

**Filtres**

**392701**



Filtre Ø 99,50 mm - H=2 mm

01245107001      01-245107-001      012451071  
01-245107-1

**395284**



Filtre 85x74 mm

01245377001      01-245377-001      012453771  
01-245377-1

**388249**



Filtre de cuve 492x225/247 mm

00231958000      00-231958-000      231958

**376153**



Filtre de cuve 255x525 mm

00898189001      00-898189-001      8981891  
898189-1

**389345**



Filtre de cuve 530x257 mm

01515598001      01-515598-001

**394364**



Filtre de cuve Ø 155 mm - H=115 mm  
[KIT]

00-883578-001      00-883582-001      01297817001  
01-297817-001      012978171      01-297817-1  
8835781      883578-1      8835821  
883582-1

**394358**



Anneau de filtre Ø 132,5x142,5x6,5 mm

01297809001      01-297809-001      012978091  
01-297809-1

**387019**



Filtre de cuve Ø 139xh80 mm

00324768000      00-324768-000      324768

**409615**



Filtre de cuve Ø 140 mm L=80 mm

00883584001      00-883584-001      8835841  
883584-1

**389346**



Filtre de cuve Ø 160 mm  
H=120 mm

01515597001      01-515597-001

**Filtres**

**409644**



Filtre de cuve Ø 157 mm

00883733002  
883733-2

00-883733-002

8837332

**409645**



Filtre de cuve Ø 157 mm

00883733001  
883733-1

00-883733-001

8837331

**398441**



Filtre Ø 115 mm H=22 mm

00775405001  
775405-1

00-775405-001

7754051

**453614**



Filtre support Ø 142xh135 mm

E80470

**450374**



Filtre Ø 153x120 mm

E121052

E121081

**453637**



Filtre Ø 93x180xh37 mm

E429072



**Composant structuraux**

**394465**



**Cover**

01297500001    01-297500-001    012975001  
01-297500-1

**380928**



**Protection 500x270x1 mm**

00494213000    00-494213-000    494213

**402716**



**Levier de vidange L=110 mm**

00375215001    00-375215-001    3752151  
375215-1

**Poignées**

**403999**



**Service KIT  
pour poignée**

00898081001    00-898081-001    8980811  
898081-1

**376398**



**Support 47x37x20 mm**

00898024001    00-898024-001    8980241  
898024-1

**403211**



**Poignée porte gris  
100x50x30 mm; M6**

E926243

**Galets roulement**

**376370**



**Galet roulement [KIT 4 Pcs]**

00898080001    00-898080-001    8980801  
898080-1

**389365**



**Roulette Ø 29 mm L=14,90 mm [KIT]**

01515688001    01-515688-001

**Thermomètres**

**402133**



**Thermometre Ø 52 mm 40÷105°C**  
bulbe Ø 11x66 mm; capillaire L=2450 mm;  
presse étoupe Ø 15,5 mm CH16 mm

00-276923-00006  
2769236  
437041-3

0043704100003  
276923-6

00-437041-00003  
4370413

**390292**



**Thermometre 30÷120°C**  
bulbe Ø 8,6x35 mm; capillaire L=3000 mm; dim  
24,70x57,70 mm

00-228720-002  
2287202  
228720-3

00228720003  
228720-2

00-228720-003  
2287203

**Composants mécaniques**

**402708**



**Circlip Ø 18,5/20x1,2**

00372955001  
372955-1

00-372955-001  
QA01146

3729551  
QA011-46

**402815**



**Circlip Ø 35x1,5 mm**

00374960001  
374960-1

00-374960-001

3749601

**405286**



**Circlip Ø 25x1 mm**

RR01013  
RR-10-13

RR-010-13

RR1013

**376017**



**Anneau Ø 41x46x3 mm**

00775933001  
00-775933-003  
015153561  
7759331  
775933-3

00-775933-001  
01515356001  
01-515356-1  
775933-1

00775933003  
01-515356-001  
01515356-1  
7759333

**378634**



**Anneau Ø 60 mm**

00324751000

00-324751-000

324751

**376065**



**Anneau Ø 45x3 mm**

00324068000

00-324068-000

324068

**399647**



**Amortisseur Ø 14xhtot.7 mm**

00323785101  
323785-101

00-323785-101

323785101

**376408**



**Tampon en caoutchouc Ø 9mm noir**

00228828000  
00-228828-001  
228828-1

00-228828-000  
228828

00228828001  
2288281

**Composants mécaniques**

**384963**



**Bride bague Ø 7/16xh9,6 mm**

00119055000      00-119055-000      119055

**439006**



**Clavette 6x6x25 mm - INOX**

00298687002      00-298687-002      2986872  
298687-2

**376083**



**Goupille fendue Ø 2,7x18mm**

00602886000      00-602886-000      602886

**438438**



**Ecoux hexagonal M6 autofreies - INOX**

00602502000      00-602502-000      602502

**322630**



**Ecoux hexagona M8x8 INOX indesserrable**

0016340900002      00-163409-00002      00-602503-000  
1634092      163409-2      602503

**381319**



**Ecoux hexagonal M12 autofreies**

00602505000      00-602505-000      602505

**200250**



**Ecoux hexagonal M6 - H=5 mm INOX**

00602491000      00-602491-000      602491

**406454**



**Ecoux hexagona M6**

NS01511      NS-015-11      NS1511  
NS-15-11

**582965**



**Ecoux hexagona M8 - INOX**

00-602492-000      602492      602492000

**381629**



**Ecoux hexagona 1/4" - H=6,60 mm**

00602476000      00-602476-000      602476

**Composants mécaniques**

**397192**



**Ecrou hexagona M32 - H=7,5 mm**

00695664005      00-695664-005      6956645  
695664-5

**390396**



**Ecrou hexagonal 3/4" - H=4,5 mm  
CH30 mm**

00172739002      00-172739-002      1727392  
172739-2

**418034**



**Ecrou hexagonal borgne M6  
H=11,5 mm**

00603036000      00-603036-000      603036

**387434**



**Ecrou molette plate M6 Ø 25 mm H=3,5/6  
mm**

00228644000      00-228644-000      228644

**376094**



**Ecrou molette plate M12x1 Ø 32 mm H=3  
mm**

00-324036-000      01240205001      01-240205-001  
012402051      01-240205-1      324036

**399592**



**Entretoise Ø 22,5x25x6,2 mm**

00324902001      00-324902-001      3249021  
324902-1

**376394**



**Entretoise 79,30x24,7x10 mm**

00-883364-001      01246900001      01-246900-001  
012469001      01-246900-1      8833641  
883364-1

**391947**



**Agrafe de tuyau Ø 15÷23/9 mm - INOX**

00166513004      00-166513-004      1665134  
166513-4

**582964**

**Collier de serrage plastique H=2,50 mm  
÷ L=160 mm**

00165128001      00-165128-001      00-699734-387  
1651281      165128-1      699734387  
699734-387

**399441**



**Collier de serrage Øint. 310/20 mm**

00324848001      00-324848-001      3248481  
324848-1

**Composants mécaniques**

**399411**



**Collier de serrage Øint. 98/20 mm**

00324735002      00-324735-002      3247352  
324735-2

**395615**



**Collier de serrage Ø 7 mm H=8,66 mm**

01246214003      01-246214-003      012462143  
01-246214-3      01-510143-001      015101431  
01-510143-1

**395616**



**Collier de serrage Ø 17 mm**

01246214002      01-246214-002      012462142  
01-246214-2

**395617**



**Collier de serrage Ø 23÷27/12 mm**

01246214001      01-246214-001      012462141  
01-246214-1

**409464**



**Bouchon Ø 35 mm**

00883271001      00-883271-001      8832711  
883271-1

**401518**



**Rouleau Ø 59,50 mm H=17,4 mm**

00377373003      00-377373-003      3773733  
377373-3

**387719**



**Bouchon 1/8"**  
L=12 mm

00226989000      00-226989-000      226989

**376410**



**Bouchon Ø 10/15xh18 mm**

00774512001      00-774512-001      7745121  
774512-1

**382085**



**Guide L=140 mm**

00375213000      00-375213-000      375213

**395654**



**Bouchon Ø 72 mm**  
filée M10x18 mm

00-229585-000      01248160001      01-248160-001  
012481601      01-248160-1      229585

## Composants mécaniques

**385249**

Plaque de fixation 54,4x15,3 mm

00142413000

00-142413-000

142413

**325216**

Plaque 25x84x2 mm

00898598001  
898598-1

00-898598-001

8985981

**376365**

Rondelle grower Ø 4,2 mm INOX

00602308000  
VC03209  
VC-32-900-602308-000  
VC032-09602308  
VC329**358211**

Rondelle grower Ø 6,3 mm INOX

00602307000

00-602307-000

602307

**432605**Rondelle plate M6 Ø 6,4x11,6x1,6 mm  
INOX00602286000  
60228600-602286-000  
603462

00-603462-000

**364457**

Rondelle plate Ø 8,5x16x1,5 mm INOX

00-602287-000  
602287000  
WAME8-3600-603617-000  
603617602287  
WAM-E-8-36**322015**

Rondelle plate M10 INOX

00602288000

00-602288-000

602288

**390297**

Rondelle plate Ø 13x27x3 mm

00228694014  
228694-14

00-228694-014

22869414

**376020**Rondelle plate Ø 14,90x19,70x0,5 mm -  
téflon00774072001  
774072-1

00-774072-001

7740721

**376019**Rondelle plate Ø 16x20,50x0,5 mm -  
téflon00774072002  
774072-2

00-774072-002

7740722

**Composants mécaniques**

**318628**



Rondelle plate Ø 49x70x3 mm - INOX

00898263001  
898263-1

00-898263-001

8982631

**522833**



Vis de fixation crantée M5x8 mm (10 pcs)

00609782000

00-609782-000

609782

**358118**



Vis tête hexagonale M6x16 - INOX

00-602570-000

602570

**435998**



Vis tête hexagonale TE M6x20 mm

00602571000

00-602571-000

602571

**358124**



Vis tête hexagonale M8x20 mm - INOX

00-602577-000

602577

**381382**



Vis tête hexagonale M8x25 mm - INOX

00602976000

00-699739-041

699739-041

SC4113

00-602976-000

602976

SC04113

SC-41-13

00699739041

699739041

SC-041-13

**376266**



Boulon à vis [KIT 4 pcs]

axe de vis Max. fil de 22 mm M5 de 10 mm L  
coulissants kit de rouleaux

00883965001  
883965-1

00-883965-001

8839651

**582729**



Vis à tête fendue M5x30 mm inox

SCME1236

SCM-E-12-36

**381681**



Vis M6x12 mm

00600699000  
600699

00-600699-000  
602632

00-602632-000

**405673**



Vis auto-taraudeuse Ø 5x12 mm

SD03884  
SD-38-84

SD-038-84

SD3884

## Composants mécaniques

### Collier de serrage avec vis



<b>376136</b>	Ø 17 mm	<b>323945-40</b>	<b>376138</b>	Bifilaire	Ø 21,50 mm	<b>323945-21</b>
<b>376140</b>	Ø 29 mm	<b>323945-29</b>	<b>399773</b>	Bifilaire	Ø 23 mm	<b>323945-22</b>
<b>376141</b>	Ø 34 mm	<b>323945-33</b>	<b>399659</b>	Bifilaire	Ø 23,50 mm	<b>323945-23</b>
<b>376143</b>	Ø 37 mm	<b>323945-37</b>	<b>376139</b>	Bifilaire	Ø 25 mm	<b>323945-25</b>
<b>376144</b>	Ø 53 mm	<b>323945-53</b>	<b>399829</b>	Bifilaire	Ø 35÷40 mm	<b>323945-40</b>
<b>376145</b>	Ø 56 mm	<b>323945-56</b>	<b>376142</b>	Bifilaire	Ø 35 mm	<b>323945-35</b>
<b>376147</b>	Ø 64 mm	<b>323945-64</b>	<b>399827</b>	Bifilaire	Ø 50 mm	<b>323945-49</b>
<b>376135</b>	Bifilaire	Ø 15 mm	<b>399826</b>	Bifilaire	Ø 69 mm	<b>323945-68</b>
<b>376137</b>	Bifilaire	Ø 18 mm	<b>399824</b>	Bifilaire	Ø 78 mm	<b>323945-76</b>

### Collier de serrage bifilaire



<b>399494</b>	Ø 6,3÷7 mm	<b>324510-73</b>	<b>399497</b>	Ø 27,00÷31,80 mm	<b>324510-313</b>
<b>399494</b>	Ø 6,6÷7 mm	<b>324510-81</b>	<b>399499</b>	Ø 22,00÷23,70 mm	<b>324510-258</b>
<b>399493</b>	Ø 7,3÷7,8 mm	<b>324510-86</b>	<b>399498</b>	Ø 25,00÷27,00 mm	<b>324510-287</b>
<b>380343</b>	Ø 8,8÷9,3 mm (5 pcs)	<b>324510-68</b>	<b>376133</b>	Ø 27,60÷29,20 mm	<b>324510-327</b>
<b>399518</b>	Ø 14,8÷15,9 mm	<b>324510-173</b>	<b>582968</b>	Ø 30,70÷32,90 mm	<b>024510-356</b>
<b>376131</b>	Ø 17,7÷18,7 mm	<b>324510-202</b>	<b>399496</b>	Ø 33,20÷34,80 mm	<b>324510-341</b>
<b>399501</b>	Ø 19,7÷20,6 mm	<b>324510-192</b>	<b>582967</b>	Ø 33,80÷36,30 mm	<b>324510-388</b>
<b>376132</b>	Ø 21÷23 mm	<b>324510-242</b>	<b>582966</b>	Ø 35,20÷39,20 mm	<b>324510-429</b>



**Joint axe**

**412354**



Joint d'étanchéité Ø 24x12x16 /  
contre-joint Ø 26x12x8 mm  
Joint d'étanchéité en TEFLON

E141007

**376384**



Joint d'étanchéité  
Ø26,7x15,5x39mm/contre-joint  
Ø32x17x10mm  
avec ressort

00104329  
104329

00-104329  
114696

00-114696

**Fermetures**

**459775**



Balle 1/4"

BA00240

BA-002-40

**376217**



Support porte L=175 mm [KIT]

00883947001  
883947-1

00-883947-001

8839471

**403998**



Support porte L=165 mm [KIT]

00898082001  
898082-1

00-898082-001

8980821

**385097**



Aimant Ø 23x11 mm

00166964000

00-166964-000

166964

**389301**



Aimant 15x12x10 mm

01515145001  
01-515145-1

01-515145-001

015151451

**392415**



Aimant avec support [KIT]  
aimant 20x10x5 mm

01-240293-001  
01-240294-001  
01240295001  
01-240295-1

012402931  
012402941  
01-240295-001

01-240293-1  
01-240294-1  
012402951

**398237**



Aimant 24x12x10 mm

00775860001  
775860-1

00-775860-001

7758601

**389454**



Aimant support 23,5x28x14,3 mm

01510648001  
01-510648-1

01-510648-001

015106481

## Fermetures

409640



**Aimant support 24x12 mm**  
dim. 24x12 mm

00883746001  
883746-1

00-883746-001

8837461

394740



**Aimant support 24,5x45/61x12,5 mm**

01297033001  
01-297033-1

01-297033-001

012970331

## Surchauffeurs

398435



**Surchauffeur 1 Résistances [kit]**  
dim. 400x140x180 mm; raccord cannèle Ø 11 mm

00775306001  
7753061  
775461-1

00-775306-001  
775306-1

00-775461-001  
7754611

456092



**Surchauffeur 3 résistances**  
dim. Ø 250x460 mm

E927067

319262



**Surchauffeur 3 résistances [KIT]**  
dim. Ø 168x450 mm; avec isolant

00323773001  
3237731  
886762-1

00-323773-001  
323773-1

00-886762-001  
8867621

## Ressort

410046



**Ressorts de compression Ø 8,10 mm**  
L=65 mm

00886839001  
886839-1

00-886839-001

8868391

384889



**Ressorts de compression Ø 23xh22 mm**

00119229000

00-119229-000

119229

387025



**Ressorts de compression Ø 37x14 mm**

00324730000

00-324730-000

324730

455960



**Ressorts de traction Ø 30x450 mm**  
Ltot.=505 mm

E926108

**Ressort**

**376397**



**Support 22x60x6 mm**

00883683002  
883683-2

00-883683-002

8836832

**395069**



**Support ressort Ø 66x32 mm**  
Ø int. 10/est. 54,5/66 mm H=32 mm

01245280001  
01-245280-1

01-245280-001

012452801

**376393**



**Tendur ressort Ø 10 mm L=285 mm**  
filée M10

00883931001  
883931-1

00-883931-001

8839311

**Rails et Montures de grille**

**404448**



**Guide L=590 mm**

0091845800001  
918458-1

00-918458-00001

9184581

**404132**



**Glissiere de porte L=665 mm [KIT]**

00898275001  
898275-1

00-898275-001

8982751

**403997**



**Guide L=470 mm (2 pcs)**

00898083001  
898083-1

00-898083-001

8980831

**Photocellule**

**388462**



**Réflecteur photocellule Ø 29x6 mm [KIT]**  
vis M3 L=8 mm; rondelle Ø 3,7x19,7x0,8 mm

00887031002	00-887031-002	00-887031-2
01537791001	01-537791-001	015377911
01-537791-1	01537791-1	8870312
887031-2		

**397232**



**Cellule photoelectrique VT18-204470**  
DC 10-230V; temperatura di lavoro -25°C....+70°C; connettore M12;4-pin

00695674010	00-695674-010	69567410
695674-10		

**400821**

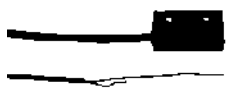

**Récepteur photocellule**  
dim. 35x19.9x12/6 mm; câble L= 5000 mm

00301763006	00-301763-006	3017636
301763-6		

**400822**



**Récepteur photocellule**  
câble L=5000 mm

00301763005	00-301763-005	3017635
301763-5		

**408817**



**Récepteur photocellule**  
dim. 15x47x33 mm

00-887031-001	00887178001	00-887178-001
8870311	887031-1	

**Platines**

**318118**

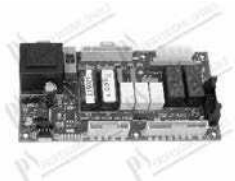

**Platine électronique**  
NT800

E215027

**315530**



**Platine électronique**  
K500/500P - ST330/330H

E215029                      E215038

**316865**



**Platine électronique (sans processeur)**  
GL71/72/71 - GS55/77 - GOLD43 - LP201 - SV71/72

E215023

**392365**

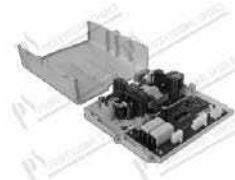

**Platine électronique**  
dim. 145x150xh45 mm - AMX / care-10A / Premax / FX/GX & FP/GP / GC/GCP

01240262001	01-240262-001	012402621
01-240262-1		

**Platines**

**376374**



**Platine électronique (sans eprom)**

00-897502-002	00-897502-012	00-897502-015
00-897502-022	00-897502-117	00-897502-217
8975021	897502117	897502-117
89750212	897502-12	89750215
897502-15	8975022	897502-2
897502217	897502-217	89750222
897502-22		

**318249**



**Platine électronique**

dim. 120x175 mm; complet avec carte processeur de contrôle - UPT

00323790001	00-323790-001	00-323790010
00-323790-010	00-3237901	00-324177-010
3237901	323790-1	32379010
323790-10	3237901V	323790-1V
32417710	324177-10	

**317682**



**Platine électronique 147x125 mm**  
ECOMAX 402 / ECOMAX 502 / AM

00897545005	00-897545-005	00897545205
00-897545-205	897545-205	8975455
897545-5		

**378604**



**Platine électronique (sans eprom)**  
dim. 120x145 mm - GX / FX / UX60

00-774505-050	77450550	774505-50
77450550V	774505-50V	

**316869**



**Carte électronique (sans eprom)**  
dim: 145x125 mm - AMX / AUX / FX/GX & FP/GP / ECOMAX 402-602 / GC / GCP

00897545001	00-897545-001	00-897545-002
00897545003	00-897545-003	00897545201
00-897545-201	897545-002	8975451
897545-1	8975452	897545-2
897545-201	8975453	897545-3

**459774**



**Platine électronique**  
dim. 140x92 mm - AM / LX

00-892934-00001	8929341	892934-1
-----------------	---------	----------

**389388**



**Platine électronique**  
dim. 185x270x45 mm

01-515050-001	015150501	01-515050-1
01-515336-001	015153361	01-515336-1
01515340001	01-515340-001	015153401
01-515340-1		

**389387**



**Platine électronique**  
dim. 150x230 mm

01-515050-002	015150502	01-515050-2
01515340002	01-515340-002	015153402
01-515340-2		

**Platines**

**404411**



**Carte électronique d'extension**  
dim. 70x120 mm

00-897546-001	00897546002	00-897546-002
00-897546-003	00897546202	00-897546-202
8975461	897546-1	8975462
897546-2	897546-202	8975463
897546-3		

**389283**



**Carte électronique**  
dim. 193x70 mm

01515051001	01-515051-001	015150511
01-515051-1		

**316870**



**Carte interface utilisateur 184x35 mm**  
AM / ECOMAX

00-897560-001	00897560002	00-897560-002
8975601	897560-1	8975602
897560-2		

**376378**



**Carte interface utilisateur**  
CNA / UX / UXL / AUX

00897501001	00-897501-001	8975011
897501-1		

**378625**



**Carte interface utilisateur 183x45 mm**

00-897540-001	00-897540-002	00897540201
00-897540-201	00897540202	00-897540-202
8975401	897540-1	8975402
897540-2	897540-201	897540-202

**382836**



**Carte interface utilisateur**  
dim. 95x45 mm; câble L=195 mm - AM / LX

00892458	00-892458	892458
----------	-----------	--------

**389466**



**Carte interface utilisateur**  
dim. 50x250 mm - AMX / FX / GX / GC

01515040001	01-515040-001	015150401
01-515040-1		

**409595**



**Capteur manque de dosage**  
dim. 57x57 mm

00883930001	00-883930-001	8839301
883930-1		

**394092**



**Capteur chimique assemble**  
dim. 57x58 mm

01294204001	01-294204-001	012942041
01-294204-1		

**455718**



**Eprom**

E81000

**Platines**

**376129**



**Eprom Rev. 4**  
HX-30 - HX-30S - HX-40 -HX-40S

00-775233-003  
7752333V

7752333  
775233-3V

775233-3

**321309**



**Eprom FW rev.10.4**

00897503002  
897503-2

00-897503-002

8975032

**582574**



**Eprom FW rev.0.7**

89750317

897503-17

**322643**



**Eprom rev. F7.7/7701**

00897547004  
897547-4

00-897547-004

8975474

**325614**



**Eprom Rev. 1.6/B301**

00-897547-015

897547-15

**408148**



**Bus câble L=6000 mm**

00785446002  
785446-2

00-785446-002

7854462

**389277**



**Usb port L=1500 MM**

01515064001  
01-515064-1

01-515064-001

015150641

**386411**



**Capteur rinçage**  
bulbe Ø 4x13 mm; M10x1; câble L=280 mm

00294692

00-294692

294692

**390328**



**Câble chart**  
L=325 mm; puntale Ø 1,2x1,7 mm

00227073090  
227073-90

00-227073-090

22707390

**408149**



**Câble nappe F/F 10B L=1740 mm**

00785446001  
7854461  
785446-4

00-785446-001  
785446-1

00-785446-004  
7854464

**Platines**

**409663**



**Câble 3 fils M/F L=2080 mm a/joint**

00883648001      00-883648-001      8836481  
883648-1

**395272**



**Boîte électrique**  
dim. 165x95x50 mm

01245373001      01-245373-001      012453731  
01-245373-1

**395243**



**Couverture pour boîte électrique**  
dim. 170x100xmm

01245374001      01-245374-001      012453741  
01-245374-1

**408466**



**Connecteur 3 phases**

00785429016      00-785429-016      78542916  
785429-16

**408465**



**Connecteur 3 phases**

00785429019      00-785429-019      78542919  
785429-19

**388646**



**Clé Usb pour AMX-14-01**

01533902001	01-533902-001	01533902006
01-533902-006	01533902007	01-533902-007
01533902008	01-533902-008	01533902009
01-533902-009	01533902010	01-533902-010
01533902011	01-533902-011	01533902012
01-533902-012	01-533902-013	01-533902-014
01-533902-015		

**386888**



**Poussoir Ø 10 mm**

00323647000      00-323647-000      323647

**Sondes**

**376064**



**Clip de fixation sonde de température**  
dim. 24,5x35x5 mm

00-324157-000      00775489001      00-775489-001  
324157      7754891      775489-1

**398058**



**Sonde de température NTC**  
bulbe Ø 4,7x35,5 mm; câble L=250 mm

00775612002      00-775612-002      7756122  
775612-2



**Sondes**

**316825**



**Sonde de température NTC**  
bulbe Ø 5x30 mm; câble L= 390 mm; INOX à partir de -40 a +110°C, avec raccord

E231014 E231016

**376388**



**Sonde de température NTC**  
bulbe Ø 5x30 mm, câble L=265 mm

00-738455-000 00775612001 00-775612-001  
738455 7756121 775612-1

**376389**



**Sonde de température NTC**  
dim. Ø 10x44 mm; rast 5 avec faston 4,8x0,8 mm

00775494001 00-775494-001 7754941  
775494-1

**376392**



**Sonde de température PTC**  
bulbe Ø 4,8x30 mm; câble L=3540 mm

00-229512-002 00378584000 00-378584-000  
2295122 229512-2 378584

**381965**



**Sonde de température Ø 4x13 mm**  
Ltot.=27,5 mm; câble L=230 mm

00328994 00-328994 328994

**389590**



**Capteur [Kit]**  
câble L=3640 mm

01515022002 01-515022-002 015150222  
01-515022-2

**389592**



**Raccord en T für capteur de turbidité**  
Ø 25 mm; L=60 mm

01515021001 01-515021-001 015150211  
01-515021-1

**Membranes**

**387023**



**Membrane adhésive 170/150x82 mm**  
UX30 / UX30S / UX60

00324755000 00-324755-000 324755

**404410**



**Membrane adhésive 185x45 mm**  
AM / FX/GX & FP/GP / AMX / AUXXT / GC

00897550001 00-897550-001 00-897557-001  
8975501 897550-1 8975571  
897557-1

## Membranes

**582960**

**Membrane adhésive 250x50 mm**  
PREMAX

01515046001      01-515046001      01-515046-001  
015150461      01-515046-1

---

**389286**

**Membrane adhésive 250x50 mm**  
PROFI

01515045001      01-515045-001      015150451  
01-515045-1

---

**404421**

**Membrane adhésive 400x45 mm**  
ECOMAX 602 / 612

00897559001      00-897559-001      8975591  
897559-1

---

**404379**

**Membrane adhésive 500x40 mm**  
UX / UXL / UXT / UXTL

00897500001      00-897500-001      8975001  
897500-1

---

**394376**

**Membrane adhesive 400x45 mm**  
Ecomax

01297749001      01-297749-001      012977491  
01-297749-1

---

**Jointts pour lave-vaisselle**

**390856**



**Joint de porte L=1500 mm**  
ECOMAX 700

00229169004      00-229169-004      2291694  
229169-4

**Jointts plats**

**391746**



**Joint en fibre Ø 17x24x2 mm**

00168611009      00-168611-009      1686119  
168611-9

**376176**



**Joint plate Ø 6x12x3 mm**

00324594000      00-324594-000      324594

**385202**



**Joint plate Ø 25x34x2 mm**

00172513000      00-172513-000      172513

**376175**



**Joint plate Ø 25,5x34x2,5 mm pour chambre air**

00775305001      00-775305-001      7753051  
775305-1

**376170**



**Joint plate Ø 47x60x0,9 mm**

00172986019      00-172986-019      17298619  
172986-19

**376179**



**Joint plate Ø 59x71x2/6 mm**

00172 986022      00-172 986-022      00172986022  
00-172986-022      172986022      172986-022  
17298622      172986-22

**376172**



**Joint plate Ø 61x71x1,6 mm**

00172986035      00-172986-035      17298635  
172986-35

**397869**



**Joint plate Ø 10,50x15x1,65 mm - Teflon**

00-168611-017      00774072003      00-774072-003  
16861117      168611-17      7740723  
774072-3

**Joints plats**

**376184**



**Joint Ø 46x68x10/2.5mm**

00226556000      00-226556-000      226556

**387458**

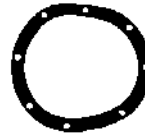

**Joint Ø 210x260x2,3 mm  
trous Ø 13 mm**

00229586000      00-229586-000      229586

**319348**



**Joint adhésif 12x2 mm [20 Mt]**

00168834006      00-168834-006      1688346  
168834-6

**O-ring**



<b>376247</b>	1,50x6,00 mm	VITON	<b>276903-55</b>	<b>435178</b>	3,53x20,22 mm	VITON	<b>06750-72</b>
<b>373031</b>	1,78x5,28 mm	EPDM	<b>E456009</b>	<b>416272</b>	3,53x23,40 mm	SILICONE	<b>67500-11</b>
<b>337127</b>	1,78x9,25 mm	NBR	<b>E456019</b>	<b>438162</b>	3,53x28,17 mm	VITON	<b>67500-12</b>
<b>456112</b>	1,78x28,30 mm	EPDM	<b>E927094</b>	<b>373114</b>	3,53x47,53 mm	EPDM	<b>276903-21</b>
<b>376250</b>	2,00x24,00 mm	VITON	<b>276903-50</b>	<b>456115</b>	3,53x50,80 mm	EPDM	<b>E927097</b>
<b>438736</b>	2,62x15,54 mm	NBR	<b>609009</b>	<b>400902</b>	5,34x37,47 mm	VITON	<b>303117-1</b>
<b>376254</b>	3,00x25,00 mm	VITON	<b>276903-56</b>	<b>438465</b>	5,34x37,47 mm	EPDM	<b>67500-150</b>
<b>434029</b>	3,00x28,00 mm	EPDM	<b>276903-9</b>	<b>612335</b>	5,34x43,82 mm (3 pcs)	VITON	<b>233982-6</b>
<b>376256</b>	3,00x83,00 mm	EPDM	<b>775465-11</b>	<b>435303</b>	5,34x46,99 mm	NBR	<b>6750081</b>
<b>392404</b>	3,00x143,00 mm		<b>01-240272-001</b>	<b>376261</b>	5,34x47,00 mm	VITON	<b>01-240135-011</b>
<b>379455</b>	3,50x34,00 mm	EPDM	<b>139321-192</b>	<b>435067</b>	5,34x56,52 mm	NBR	<b>67500-118</b>
				<b>453928</b>	5,34x136,50 mm	EPDM	<b>E456076</b>

**Paniers pour lavevaisselles**

**404152**



Support panier 490x490x55 mm

00-883280-001  
8832801  
898156-1

00898156001  
883280-1

00-898156-001  
8981561

**323253**



Panier 500x500xh105 mm - pour couverts

C0107

C-01-07

**323246**



Panier 500x500xh105 mm - 18 assiettes  
ou 12 assietes creuses

P1812

P-18-12

**Pieds**

**404849**



Pied réglable INOX 2" - H=155÷230 mm  
vis M10

00899605003  
899605-3

00-899605-003

8996053



# **Lave-batterie**

**Composants Electriques**

**Composants Eau**

**Composants Mécaniques**

**Composants électroniques**

**Joints**

## Interrupteurs, Boutons, Sélecteurs

**383600**

**Sectionneur principal [KIT]**  
dim. 69x120x80 mm

00695530000

00-695530-000

695530

**400801**

**Sectionneur principal [KIT]**

100A 220/690V; extension Ø 8,50xLtot 215 mm

00301773001  
301773-1

00-301773-001

3017731

**393006**

**Poussoir double O-I Ø 22 mm**  
dim. 30x50 mm; sans contacts

00-738650-001  
00740522-1  
740522100740522001  
738650100-740522-001  
738650-1**362975**

**Interrupteur bipolaire 16A 250V - ROLD**

62208010

62-208010

E208010

**364239**

**Interrupteur bipolaire 16A 250V - ROLD instable**

139321455

139321-455

E226071

**410144**

**Poussoir vert Ø 22 mm**  
sans contacts auxiliaires

00887015022  
887015-22

00-887015-022

88701522

**402613**

**Capuchon bouton poussoir 23x24 mm**

00374331001  
374331-1

00-374331-001

3743311

**376424**

**Boutton 27x27xH35 mm**

00324266001  
324266-1

00-324266-001

3242661

**397964**

**Groupe contacts 250V 6(4)A**  
dim. 22,2x22,2x26 mm; faston 2,8x0,8 mm

00774793005  
774793-5

00-774793-005

7747935

**376228**



**Lentille "Horloge"**  
dim. 16,5x16,5 mm

00324265001  
324265-1

00-324265-001

3242651



**Interrupteurs, Boutons, Sélecteurs**



<p><b>410089</b></p>  <p><b>E'tiquette vidange et remplissage</b> dim. 18x27 mm</p>	<p><b>376423</b></p>  <p><b>Bouton Ø 21mm avec Lentille</b></p>	
<p>00887016027 887016-27</p>	<p>00-887016-027 88701627</p>	<p>E227061</p>

**Lampes et Carters de Lampe**

<p><b>340396</b></p>  <p><b>Voyant fluorescent Ø 9 mm 240V</b> L=55 mm - faston 6,3x0,8 mm</p>	<p>E216006</p>
--	----------------

**Contacteurs et Relais**

<p><b>391087</b></p>  <p><b>Contacteur 100-K09KF10</b> 3kW 3P; 230/240V 50/60Hz; 4kW 400V 50/60Hz; 3 cont. NO + 1 aux NO; dim. 53x45x54 mm</p>	<p><b>376077</b></p>  <p><b>Contacteur LC1K0601M7</b> 1,5kW 3P; 220/230V 50/60Hz; 2,2 kW 380/415V 50/60Hz; 3 cont. NO + 1 aux NC</p>				
<p>00-141440-001 00740520001 141440-1 740520-001</p>	<p>00141440002 00-740520-001 1414402</p>	<p>00-141440-002 1414401 141440-2</p>	<p>00-232478-001 00695521002 00-699734-637 6955211 695521-2</p>	<p>00695521001 00-695521-002 2324781 695521-1 699734637</p>	<p>00-695521-001 00-695521-1 232478-1 6955212 699734-637</p>

<p><b>376076</b></p>  <p><b>Contacteur LC1D18 230V 50Hz</b> 7,5kW 3P; 4 kW 230V 400V; 3 cont. NO + 1 aux NO + 1 aux NC; dim. 85x45x72 mm</p>	<p><b>409701</b></p>  <p><b>Relais 2P 120Vac</b> 20A 400Vac; faston 6,3x0,8 mm</p>				
<p>00296926001 00-296926-002 2969261 296926-2</p>	<p>00-296926-001 00-296926-1 296926-1 699734631</p>	<p>00296926002 00-699734-631 2969262 699734-631</p>	<p>000877140421 87714-42-1</p>	<p>00-087714-042-1</p>	<p>87714421</p>



## Contacteurs et Relais

**364351**

**Relais 3 contacts 230V 50/60Hz 16A**  
Faston 6.3x0.8 mm

E229036  
MRTFOC00144

E229039

E229040

**376319**

**Relais temporisé 0,02s-300h 12-240V**  
**AC/DC**  
dim. 58x18x90 mm

00774103002  
774103-2

00-774103-002

7741032

**396914**

**Relais temporisé 3-300 sec. 220-240V**  
**50/60Hz**  
dim. 80x22x78 mm

00493530001  
493530-1

00-493530-001

4935301

## Microinterrupteurs

**376208**

**Interrupteur fin de course 1NO/1NC L=93**  
**mm**

00226916000

00-226916-000

226916

**376214**

**Microinterrupteur magnétique Ø**  
**5,6x25,5 mm**  
câble L=330 mm

01240288001  
01-240288-1

01-240288-001

012402881

**384291**

**Microinterrupteur magnétique M8x0,75 L=42**  
**mm**  
1 NO, 200Vdc/250Vac 1A 50W; câble L=310  
mm

00-738942-000  
738942

00740173000  
740173

00-740173-000

**435219**

**Microinterrupteur magnétique**  
NO contact 250V 50VA 0,04A - passo 5

00775491001  
775491-1

00-775491-001

7754911

**376213**

**Microinterrupteur magnétique 100VA**  
**0,2A 250Vac/dc IP67**  
1 NO; câble L=3900 mm

00229517002  
229517-2

00-229517-002

2295172

**404634**

**Interrupteur à flotteur Ø 9,5x52 mm**  
raccord 1/4"; câble L=130 mm

0093654700001  
00-936547-3  
936547-3

00-936547-00001  
9365471

00-936547-003  
936547-1

## Microinterrupteurs

**376164**

**Flotteur avec aimant Ø 45 mm H=33 mm**  
dim: 60x48x33 mm

00122674      00-122674      00122674000  
00-122674-000      122674

**384849**

**Charniere pour flotteur**  
dim: 20x29x1.5 mm

00112467      00-112467      00112467000  
00-112467-000      112467

**434975**

**Interrupteur à flotteur Ø 18x52 mm**  
câble L=1000 mm; fileté M16

00-735171-001      00774033001      00-774033-001  
7351711      735171-1      7740331  
774033-1      896960

**397885**

**Bride pour flotteur 434975**  
Ø 16x61x4 mm; trous Ø 6 mm

00774010001      00-774010-001      7740101  
774010-1

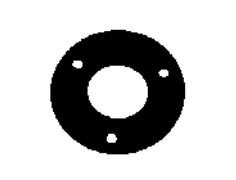
**397881**

**Joint Ø 24x52,5x4 mm**  
trous Ø 4,5 mm

00774034001      00-774034-001      7740341  
774034-1

**376399**

**Support aimant**

00883838001      00-883838-001      8838381  
883838-1

## Pressostats

**376465**

**Pressostat 1 niveau 0÷50 mbar 0,5÷3,5 VDC**  
IN 5Vdc; Pmax 200mbar; mod.  
AM900/AMS900/FP/FXN/FXS/GXS/FPS/GPS

00775866002      00-775866-002      7758662  
775866-2

**305962**

**Pressostat 1 niveau 35/17 mbar**  
contact capacité 16A 250V; Tmax 85°C

139321521      E224004

**451289**

**Pressostat 1 niveau 90/56 mbar**  
contact capacité 16A 250V; Tmax 85°C

E224005

**428812**

**Pressostat 1 niveau 110/70 mbar**  
contact capacité 16A 250V; Tmax 85°C

E224010

## Pressostats

376302



Pressostat 3 niveau Ø 84 mm 40/25 92/77  
160/140 mbar

00378758005  
378758-5

00-378758-005

3787585

401503



Pressostat 3 niveau 40/25-92/77-160/140  
mbar

00378760004  
378760-4

00-378760-004

3787604

409445



Pressostat eau -1±0,5 bar  
6A 250V

00883356001  
883356-1

00-883356-001

8833561

## Ventilateurs

319289



Ventilateur tangentiel Ø 80x500 mm; 50W  
230V 50Hz  
1330 TR/MIN ; Moteur DX ; IP44 avec câbles  
L=150 mm; condensateur de mise en phase  
1,5 µF

01294642001  
01-294642-1

01-294642-001

012946421

## Fusibles, Condensateurs, Filtres RFI

311818



Condensateur de mise en phase 4µF  
450V 50/60Hz  
Ø 30x71 mm; avec vis M8 et ecrou

00226568002  
226568-2

00-226568-002

2265682

418004



Condensateur de mise en phase 5µF  
400V 50/60Hz  
Ø 30x51 mm; avec vis M8

00226568009  
226568-9

00-226568-009

2265689

332311



Condensateur de mise en phase 10 µF  
400/450V 50/60Hz  
Ø 30x71 mm; ecrou M8

00226568010  
226568-10

00-226568-010

22656810

344792



Condensateur de mise en phase 16µF  
450V 50/60Hz  
Ø 30x71 mm; avec vis M8

00226568013  
22656813  
232210-1

00-226568-013  
226568-13  
E206004

00-232210-001  
2322101

**Fusibles, Condensateurs, Filtres RFI**

**390145**



**Condensateur de mise en phase 8µF  
400V 50/60Hz**  
Ø 30x82 mm; avec vis M8

00139321009	00-139321-009	00-226568-014
00226568017	00-226568-017	00844956000
00-844956-000	139321-9	22656814
226568-14	844956	

**315350**



**Fusible Ø 5x20 mm 0,50A 250V rapidee**

00785539027	00-785539-027	69561511
695615-11	78553927	785539-27

**435516**



**Fusible Ø 5x20 mm 0,25A 250V retardé**

00300099003	00-300099-003	300099-03
3000993	300099-3	

**312599**



**Fusible Ø 5x20 mm 1A 250V retardé**

00785539070	00-785539-070	6956152
695615-2	78553970	785539-70

**397484**



**Fusible Ø 5x20 mm 1,6A 250V retardé**

00695615003	00-695615-003	00785539072
00-785539-072	6956153	695615-3
785539-072	78553972	785539-72

**451463**



**Fusible Ø 5x20 mm 4A retardé**

E228010

**320007**



**Fusible Ø 5x20 mm 6,3A 250V retardé (10 pz)**

00785539078	00-785539-078	78553978
785539-78		

**376162**



**Fusible Ø 6,3x32 mm 0,8A 250V rapidee**

00775570002	00-775570-002	7755702
775570-2		

**376163**



**Fusible Ø 6,3x32 mm 6,3A 250V rapidee**

00-152480-022	00775570001	00-775570-001
15248022	152480-22	7755701
775570-1		

**393748**



**Fusible 250mA 250V retardé**

0091478200009	00-914782-00009	00914782009
00-914782-009		

## Moteurs

391859



**Moteur 3 phases 180W 240/415V 1,2/0,7A**  
 axe Ø 14x41 mm; clavette 5x30 mm; avec vis  
 TE 6x16 mm; 1380/1680rpm

00145075006  
 145075-6

00-145075-006

1450756

400611



**Motor 3 phases 740W 200-240/380-416V**  
**50Hz**  
 axe Ø 16x46 mm

0027423000008  
 274230-8

00-274230-00008

2742308

319327



**Moteur 3 phases 4000W 220-240/380-420V**  
**8,2/14A 50Hz**  
 axe L=80 mm M10

00229136025  
 229136-25

00-229136-025

22913625

400625



**Anneau d'étanchéité Ø 18x37x14 mm**

0027422700002  
 274227-2

00-274227-00002

2742272

400624



**Adaptateur Ø 40x165xh40 mm**

0027422700003  
 274227-3

00-274227-00003

2742273

401315



**Helice Ø 236 mm 50Hz**  
 pour axe Ø 14 mm

00038933009  
 38933-9

00-038933-009

389339

454275



**Bague inférieure Ø 25x51x51 mm**  
 filetage 1" 1/4

E60356

456114



**Bague Ø 30x61,5x55 mm**  
 filetage 1" 1/4

E927096

456110



**Rouleau Ø 16x30x30 mm**

E927092

456113



**Anneau d'étanchéité Ø 30x40x7 mm**

E927095

## Moteurs

456116



Rondelle plate Ø 42x60x2 mm - laiton

E927098

456117

Ecrou 1" 1/4 - laiton  
H=17 mm; CH50

E927099

## Pompes

376279

Pompe de vidange 80W 220-240V 50Hz  
aspiration Ø 24 mm; sortie Ø 24 mm; faston P500-165653-001  
00883993001  
165653-1  
8835271  
883993-100-699736-052  
00-883993-001  
699736052  
883527-100-883527-001  
1656531  
699736-052  
8839931

399603

Pompe de vidange 3P 155W 380/415V  
50Hz  
aspiration Ø 28 mm; sortie Ø 26 mm; câble  
L=530 mm00324913004  
324913-400-324913-004  
3249134V3249134  
324913-4V

376286

Pompe de vidange 1 phase 220W  
220-240V 1A 50Hz - SX  
aspiration Ø 28 mm; sortie Ø 26 mm; câble  
L=430 mm; câble L=615 mm; C=5µF 400V;  
AMX, AUXX00324913001  
00-324913-1  
3249131V00-324913-001  
3249131  
324913-1V003249131  
324913-1

378648

Pompe de lavage 3 phases 2900W  
220/240V 380/415V 50Hz  
aspiration Ø 61 mm; sortie Ø 62 mm; câble  
L=360 mm; avec bride01-510510001  
015105101  
01-510510-10  
01510686101-510510-001  
01-510510-1  
01510686001  
01-510686-101-510510-010  
0151051010  
01-510686-001

404114

Pompe de lavage 3 phases 2900W  
220-240/380-415V 50Hz - SX  
aspiration Ø 61 mm; sortie Ø 61 mm00898334001  
898334-1

00-898334-001

8983341

378649

Pompe de lavage 3 phases 2900W  
220/380V 8,4-4,8A 50Hz - DX  
aspiration Ø 61 mm; sortie Ø 61 mm; câble L =  
300 mm00785440001  
785440-1

00-785440-001

7854401

316688

Pompe de lavage 1 phase 600W 230V  
50/60Hz 3,8A  
aspiration Ø 50 mm; sortie Ø 50 mm; C=16µF

139321963

E130109

378637

Pompe de rinçage 1 phase 270W  
220-240V 1,3A 50Hz  
aspiration Ø 28 mm; sortie Ø 26 mm; câble  
L=650 mm; câble L=470 mm; C=5µF 400V00324914001  
3249141  
324914-1V00-324914-001  
324914-100-324914-1  
3249141V

## Pompes

398239



**Pompe de rinçage 1 phase 140/160W  
220-240V 50/60Hz - SX**  
aspiration Ø 27,5 mm; sortie Ø 26 mm; turbine  
en INOX

00-775854-002  
775854-2

00775854003  
7758543

00-775854-003  
775854-3

376277



**Pompe de rinçage 1 phase 270W  
220/240V 1,3A 50Hz SX**  
aspiration Ø 28 mm sortie Ø 26 mm; C=5µF  
400V

00-324093-021  
32409321V

32409321  
324093-21V

324093-21

382818



**Couvercle de pompe [KIT]**

00895447000  
012451131

00-895447-000  
01-245113-1

01-245113-001  
895447

390941



**Turbine Ø 120 mm 2,2kW 50Hz**

00229137001  
229137-1

00-229137-001

2291371

376194



**Joint couvercle de pompe**

00229402000

00-229402-000

229402

613978



**Pompe de rinçage 1 phase 220W 230V  
1,1A 50 Hz**  
SAPIN 5213; aspiration Ø 30 mm; sortie Ø 26  
mm; 2800 rpm; C=5 µF 400V  
(Pour les machines electrolux avec n° de  
série.<60800000 voir KIT OL1640)

E929167

404086



**Couvercle pour pompe de lavage 3/4"**  
pour pompe 456569 - 456571

E111023

378639



**Service KIT - pour pompe de lavage  
378649**

00785440010  
00-898116-010  
88325310  
898116-10

00-785440-010  
78544010  
883253-10

00-883253-010  
785440-10  
89811610

385101



**Turbine Ø 135 mm**  
trou Ø 11 mm

00166679000

00-166679-000

166679

450905



**Soupape de ventilation L=142 mm**  
embout pour tuyau Ø 18 mm/Ø21 mm

E144003

## Pompes

400619



**Impulseur et manchon**  
dim: 80x75 mm; axe Ø 19 mm

0027422700008 00-274227-00008 2742278  
274227-8

393247



**Impulseur et manchon Ø 74 mm**  
axe Ø 19 mm

0027422700011 00-274227-00011 00274227011  
00-274227-011

406768



**Protection plastique**  
dim. 170x260xh0,3 mm

00867014001 00-867014-001 8670141  
867014-1

## Résistances

376336



**Résistance surchauffeur 3270W 240V**  
dim. 415x65 mm; bride 80x29 mm avec joint;  
faston 6,3x0,8 mm

00324644001 00-324644-001 3246441  
324644-1

376339



**Résistance surchauffeur 4880W 254V**  
L=420 mm

00324637002 00-324637-002 00324637102  
00-324637-102 324637-02 324637102  
324637-102 3246372 324637-2

376343



**Résistance surchauffeur 6540W-240V**  
L=415 mm; bride 81x28 mm; faston 6,3 mm;  
avec joint

00324637001 00-324637-001 00324637101  
00-324637-101 324637-01 3246371  
324637-1 324637101 324637-101

378616



**Résistance surchauffeur 7320W 254V**  
L=345 mm; Ø 73 mm; faston 6,3x0,8 mm; Vis  
M10

00323949001 00-323949-001 3239491  
323949-1

378617



**Résistance surchauffeur 7260W 250V**  
L=380 mm; triangulaire bride; avec decoupé  
pour bulbe Ø 5 mm, avec O-ring

01-240135-001 01240135002 01-240135-002  
012401351 01-240135-1 012401352  
01-240135-2

392473

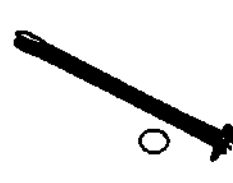

**Résistance surchauffeur 10620W 250V**  
L=540; triangulaire bride 83,5x79 mm; Øint,  
49,50 mm; avec decoupé pour bulbe L=225  
mm; faston 6.3x0.8 mm

01240135003 01-240135-003 012401353  
01-240135-3



## Résistances

**318965****Résistance cuve 5500W 440V**

dim. 515x130 mm, avec joint et bride de fixation

00-324241-001  
3242411  
326241-100326241001  
324241-100-326241-001  
3262411**399819****Résistance cuve 4050W 254V**00323949002  
323949-2

00-323949-002

3239492

**393652****Résistance cuve 15000W 380V**

dim. 425x195x40 mm; bride Ø 75,6 mm

0091954900003  
00-919549-003  
919549-00300-919549-00003  
00-974568-0000300919549003  
00-974568-003**451501****Résistance cuve 600W 230V**

L=160 mm; bride 50x26,5 mm; faston 6,3x0,8 mm

E230098

**322368****Résistance 7500W 220V**00229148011  
229148-11

00-229148-011

22914811

**376361****Résistance 9000W 240V**

L=510 mm; bride Ø 74,5 mm; raccord M4

00229148002  
229148-2

00-229148-002

2291482

**390934****Résistance 9000W 254V**00229148005  
229148-5

00-229148-005

2291485

**387539****Joint 70x70x4 mm**

00229516000

00-229516-000

229516

**385175****Joint 201x136x2 mm**

00170309000

00-170309-000

170309

**405840****Câble de connexion**00227073029  
2270732900-227073-029  
227073-29227073-029  
ML102844

## Résistances

**397952****Bride avec joint 29x80,5 mm**00774808001  
774808-1

00-774808-001

7748081

## Commutateurs, Régulateurs d'energie

**376068****Commutateurs 0-4 positions**  
D-axe Ø 6x4,6 mm L=23 mm

00845259000

00-845259-000

845259

## Transformateurs

**390229****Transformateur 400W 50/60Hz**  
dim. 112x126x107 mm; PRI- 400-415-440V -  
SEC- 220/230V00226211015  
226211-15

00-226211-015

22621115

**397529****Transformateur 440-200/220-240 630 VA**00226211015  
226211-15

00-226211-015

22621115

00695543001  
695543100-695543-001  
695543-1

695543-001

## Câbles

**382797****Boîte de connexion [KIT]**  
dim. 90x90x35 mm00-229513-002  
229513200896967000  
229513-200-896967-000  
896967**376298****Passe-fils à vis M32 - câble Ø 21 mm**00-229513-002  
229513200896967000  
229513-200-896967-000  
89696700695661005  
695661-5

00-695661-005

6956615

**385626****Passe-fils Ø 12,5x20,5x7 mm**

00064824

00-064824

64824

**376310****Pass-fil Ø 29x41 mm**

00064824

00-064824

64824

00886756003  
886756-3

00-886756-003

8867563

## Thermostats

**318112****Thermostat à contact 95°C 1P**

E236047

E926189

**383428****Thermostat d'utilisation 1P 85°C**

capillaire revêtu L=1150 mm; bulbe Ø 4x200 mm; axe Ø 6x3,3 mm; faston 6,3x0,8 mm

00-226505-004  
226505004  
89792700897927000  
226505400-897927-000  
226505-4**376458****Thermostat d'utilisation 1P 95°C**

capillaire revêtu L=1180 mm; bulbe Ø 4x220 mm; 16A 250V

00-226505-000  
22650500886638000  
886638

00-886638-000

**400373****Thermostat d'utilisation 1P 86÷266°F**

capillaire L=1200 mm; bulbe Ø 13x130 mm; presse étoupe M17

002946810312  
294681-31-2

00-294681-031-2

294681312

**317003****Thermostat de sécurité 1P 83°C**

capillaire L=3150 mm; bulbe Ø 6x95 mm

00139321019  
13932119  
139321-39800-139321-019  
139321-19  
E23604300-139321-398  
139321398**376447****Thermostat de sécurité 3P 100°C 20A**

capillaire revêtu L=870 mm; bulbe Ø 4x230 mm

00378791000

00-378791-000

378791

**387713****Presse-étoupe M12x1 [KIT]**

00227024000

00-227024-000

227024

## Rideaux

383225



**Rideau 4 quadruple 565xh520/385/270 mm**  
certifié NSF

00919758      00-919758      919758

383229



**Rideau double 598xh355 mm**  
sans axe - certifié NFE

00919509      00-919509      919509

316718



**Rideau double 1100xh550 mm - Azzurra**  
sans axe

00-229436-004      2294364      229436-4

## Groupe de lavage

378650



**Bras de lavage 690x690 mm**  
moyeu Øint.16/est. 24 mm - ECOMAX 700,  
UXT-UXTS / UXTL-UXTLS,  
UXTH-UXTHS/UXTLH-UXTLHS

00-324691-000      00324798002      00-324798-002  
324691      324691000      3247982  
324798-2

378651



**Bras de lavage 692x692 mm**  
moyeu Øest. 22 mm - UXT / UPT, UXTH /  
UXTLH

01294687001      01-294687-001      012946871  
01-294687-1

376055



**Bras de rinçage L=515 mm**  
AM10 / AM11 / AM141, AMX - AMXX / AUXX -  
AUP, ECOMAX 502, FX/GX & FP/GP, UXT /  
UPT

01-240084-003      012400843      01-240084-3  
01240096003      01-240096-003      012400963  
01-240096-3

378636



**Bras de rinçage L=680 mm**  
UXTH / UXTLH

01294641001      01-294641-001      012946411  
01-294641-1      01-294879-001      012948791  
01-294879-1

378635



**Bras de rinçage L=680 mm**  
moyeu Ø 18,5 mm - M13 - ECOMAX 700,  
UXT-UXTS / UXTL-UXTLS,  
UXTH-UXTHS/UXTLH-UXTLHS

00-324738-000      00-324831-000      00886898001  
00-886898-001      324738      324831  
88689801      8868981      886898-1

339981



**Moyeu pour jet**

13932135      E129039

## Groupe de lavage

419146



Moyeu pour jet

E115075

409473



Axe support jet Ø 16,8 mm - L=85,5 mm

00883500001  
883500-1

00-883500-001

8835001

409472



Axe support jet Ø 17 mm - L=75,5 mm

00883500002  
883500-2

00-883500-002

8835002

376406



Support bras lavage supérieur

Øint./est. 53/62 mm; axe Øest. 16x59 mm

00-324670-000  
32467000886607000  
886607

00-886607-000

322484

Support bras lavage supérieur  
axe pour support Ø 16x59 mm00883125001  
883125-1

00-883125-001

8831251

409810

Support bras lavage supérieur  
axe pour support Ø 16x59,50 mm00883125002  
883125-2

00-883125-002

8831252

394659

Support bras de lavage supérieur  
raccord cannelé Ø 14mm, Ø 50 mm01294619001  
01-294619-1

01-294619-001

012946191

376405



Support bras lavage supérieur

01-240013-001  
01294038001  
01-294038-1012400131  
01-294038-00101-240013-1  
012940381

394690

Support bras lavage inférieur  
L=150 mm01294757001  
01-294757-1

01-294757-001

012947571

322113



Ecrou support bras de lavage

Ø 53.2x74x35 mm; CH 65 mm; système de lavage gauche

00324698002  
324698-2

00-324698-002

3246982

## Groupe de lavage

409488



Support bras lavage supérieur

00883466001  
883466-1

00-883466-001

8834661

315727



Support bras lavage supérieur

E111030

387024

Tuyau de branchement jets  
dim. 500x425x250 mm; vis M6

00324734000

00-324734-000

324734

383831

Bouchon 3/4"  
Ø 32 mm, 14x14 mm

00603412000

00-603412-000

603412

318191



Bouchon [4 pcs]

00-324172-000  
00886609000  
867429100867429001  
00-886609-000  
867429-100-867429-001  
324172  
886609

434446

Support  
Øext. 38/ext. 59 mm H=70 mm

E115110

450791

Support bras lavage Øint. 102/est. 140 mm  
tuyau; 1 x Øest. 50 mm, 1 x Øest. 60 mm

E136020

322120



Tuyau de branchement jets

00323689000

00-323689-000

323689

392680



Bouchon jet de rinçage Ø 23,5x28xH28 mm

01245080001  
01-245080-1

01-245080-001

012450801

382678

Bouchon pour bras de lavage [4 pcs]  
Ø 28x10 mm; M2300-324785-000  
32478500886610000  
886610

00-886610-000

## Groupe de lavage

**392681****Bouchon bras de rinçage Ø 24,5 mm**

01245080002

01-245080-002

**387361****Bouchon Ltot=27 mm**

00229330000

00-229330-000

229330

**339694****Injecteur bras de lavage, LTB**

139321-31

139321-32

E140008

**339698****Injecteur bras de rinçage**

139321-34

E140007

**376066****Raccord Ø 23 mm - Ltot=55 mm**01240159001  
01-240159-1

01-240159-001

012401591

**386898****Raccord 90° sortie Ø 18 mm**

00324097000

00-324097-000

324097

**398474****Agrafe de tuyau Ø 26x10 mm**00775512001  
775512-1

00-775512-001

7755121

**376090****Bague bras de lavage avec écrou Ø 24 mm - H=58 mm**00-324727-000  
324727  
734804-100734804001  
73480400100-734804-001  
7348041**376038****Bague bras de lavage avec écrou Ø 22 mm - H=56 mm**00-883452-002  
015106771  
015106781  
01-510702-001  
8834522  
883974-200-883974-002  
01-510677-1  
01-510678-1  
015107021  
883452-201-510677-001  
01-510678-001  
01510702001  
01-510702-1  
8839742**376101****Écrou support bras de lavage  
Ø 53.2x74x44,5 mm; CH 65 mm**00324698001  
324698-1

00-324698-001

3246981

## Groupe de lavage

**376102**

**Ecrou Ø 34,5x7,5 mm**  
CH 30 mm

00324384000

00-324384-000

324384

**376099**

**Ecrou support bras de lavage Ø 60 mm**

01240021001  
01-240021-1

01-240021-001

012400211

**409476**

**Ecrou Øint52.60 mm H=34,60 mm**

00883497001  
883497-1

00-883497-001

8834971

**409475**

**Ecrou 2" H=44,5 mm**

00883497002  
883497-2

00-883497-002

8834972

**317536**

**Anneau Ø 48x23 mm**

00229568002  
229568-2

00-229568-002

2295682

**387026**

**Anneau plastique Ø 50x33,5/37,3x5,5 mm**

00324729000

00-324729-000

324729

**319339**

**Joint 100x78x2 mm**

00296709000  
01242580100-296709-000  
01-242580-101-242580-001  
296709**376190**

**Joint plane Ø 12x18x2 mm**

00229323000

00-229323-000

229323

**376021**

**Anneau TEFLON Ø 13x24x1 mm**

00774072007  
774072-7

00-774072-007

7740727

**450976**

**Défecteur Ø 63xh20 mm**

E199058



**Groupe de lavage**

**319342**



**Etrier de serrage**

00-229112-000    00-229182-000    00784303001  
 00-784303-001    229112    229182  
 7843031    784303-1

**376268**



**Tige de bras de rinçage**

01240095001    01-240095-001    012400951  
 01-240095-1

**452765**



**Joint Ø 40x44x3 mm**

E303032

**339904**



**Collier injecteur de rinçage**

139321-33    E429006

**Chambres air**

**387058**



**Écrou chambre de compression**  
 H=20 mm

00324183000    00-324183-000    324183

**376496**



**Chambre de compression [KIT]**  
 mod. ECOMAX avec adoucisseur

00775540001    00-775540-001    00-895457-000  
 01297510001    01-297510-001    01-297510-002  
 012975101    01-297510-1    012975102  
 01-297510-2    01297695001    01-297695-001  
 012976951    01-297695-1    7755401  
 775540-1    895457

**317923**



**Chambre de compression Øext 34,5x80 mm**

E107005

**376500**



**Chambre de compression**  
 embout tuyau Ø 13 mm; mod. ECOMAX 602-1C sans adoucisseur

00775759001    00-775759-001    7757591  
 775759-1

**315746**



**Chambre de compression 84x81x42mm**  
 avec raccord, collier de serrage bifilaire, joint torique et vis

00139321047    00-139321-047    13932147  
 139321-47

**376462**



**Chambre de compression [Kit]**  
 O-ring Ø 3x24 mm

01240372001    01-240372-001    012403721  
 01-240372-1    01-246204-001    012462041  
 01-246204-1

## Chambres air

376497



**Chambre de compression [KIT]**  
dim. 625x140x35 mm

00886641000

00-886641-000

886641

## Serpentin

318197



**Echangeur thermique à vapeur**  
dim. 600x210x140 mm

00229742000

00-229742-000

229742

## Doseurs, Doseur péristaltique

361240



**Doseur hydraulique de rinçage débit réglable 1÷5 cc.**  
mod. DIB-5E; connection EV-surchauffeur - IN 180° et OUT 180° pour tuyau de Ø 4x6 mm

E209025

383426



**Doseur péristaltique rinçage débit fixe (U. interne)**  
mod. PG-0,4; débit fixe 0,4 L/h; 1 bar; 230V 50/60Hz; câble L=430 mm; tuyau en sekobril; protection 197x124x0,15 mm PVC

00-775556-001  
775556100897930000  
775556-100-897930-000  
897930

409605



**Doseur péristaltique rinçage (U. interne)**  
DSP 9911/03-AH; 4,9W 230V 50/60Hz

00883860001  
883860-1

00-883860-001

8838601

383425



**Doseur péristaltique lavage débit fixe (U. interne)**  
mod. PG-3; débit fixe 3 L/h; 0,1 bar; 230V 50Hz; câble L=470 mm; tuyau en Santoprene; protection 197x124x0,15 mm PVC

00-775556-002  
775556200897931000  
775556-200-897931-000  
897931

406539



**Doseur péristaltique lavage débit fixe [KIT]**  
mod. PG-3; débit fixe 3 L/h; 0,1 bar; 230V 50Hz; câble L=470 mm; tuyau en Santoprene; protection 197x124x0,15 mm PVC

ML71561ED

ML71561-ED

**Doseurs, Doseur péristaltique**

**700431**



**Doseur péristaltique lavage débit réglable (U. interne)**  
 mod. PBR-3; réglage débit 0,3÷3 lt/h 0,1 bar;  
 230V 50Hz; câble L=200 mm; cpl. Kit d'installation

E209016

**409604**



**Doseur péristaltique lavage**  
 230V 50/60Hz 4,9/5,4W; câble L= 620 mm

00883860002      00-883860-002      8838602  
 883860-2

**392406**



**Tuyau doseur rinçage**  
 Øest. 6,5 mm, raccord Ø 4/4,5 mm

00-883860-011      01240195011      01-240195-011  
 0124019511      01-240195-11      01515268011  
 01-515268-011      0151526811      01-515268-11  
 88386011      883860-11

**392477**



**Tuyau doseur lavage**  
 Øest. 8 mm; raccord Ø 4/4,5 mm

00-883860-012      01240195012      01-240195-012  
 0124019512      01-240195-12      01515268012  
 01-515268-012      0151526812      01-515268-12  
 88386012      883860-12

**365039**



**Tuyau en PVC Ø 4x6 mm (vendu au mètre)**

00-324402-000      00-324402-099      00-493424-000  
 00-898252002      00-898252-002      01246301008  
 01-246301008      01-246301-008      01246301016  
 01-246301-016      0124630108      01-24630108  
 01-246301-08      01246301099      01-246301-099  
 0124630116      01-246301-16      012463018  
 01-2463018      01-246301-8      01-246301-99  
 01515410002      01-515410-002      01-515410-008  
 01515410016      01-515410-016      01515410099  
 01-515410-099      01-515410-2      324402  
 32440299      324402-99      493424  
 775601      8982522      898252-2

**200253**



**Tuyau en PVC transparent Ø 4x6 mm L=2660 mm**

00898252003      00-898252-003      00898252005  
 00-898252-005      01-246301-010      0124630110  
 01-24630110      01-246301-10      01515410010  
 01-515410-010      01-51541010      01-515410-10  
 8982523      898252-3      8982525

**410462**



**Tuyau en PVC transparent Ø 4x6 mm L=4000 mm**

01-246145-001      012461451      01-246145-1  
 01246301001      01-246301-001      01246301011  
 01-246301011      01-246301-011      012463011  
 01-246301-1      0124630111      01-246301-11  
 01515410001      01-515410-001      01-515410-011  
 12463011      15154101

**339721**



**Tuyau en PVC vert Ø 4x7 mm [vendu au mètre]**

139321-200      3244025      E143013

## Doseurs, Doseur péristaltique

**376231**

**Tuyau PE bleu Ø 8x10x40 mm**

01246210001  
01-246210-1

01-246210-001

012462101

**410373**

**Filtre d'aspiration in inox pour tuyau Ø 4x6 mm**

00775239001  
7752391

00-775239-001  
775239-1

775239-01  
E121075

**376152**

**Filtre d'aspiration in inox pour tuyau Ø 6 mm**

00-227441-000  
227441

00227441001  
2274411

00-227441-001  
227441-1

**376316**

**Raccord 1/8" - L=44 mm  
pour tuyau Ø 5 mm**

01240452001  
01-240452-1

01-240452-001

012404521

**376095**

**Ecrou M9x1  
pour tuyau Ø 6 mm**

00775507001  
775507-1

00-775507-001

7755071

**376312**

**Raccord Ø 5 mm [KIT]  
fileté M10**

00883676001  
8836761  
883676-2

00-883676-001  
883676-1

00-883676-002  
8836762

**311413**

**Raccord 90° M12 mm inox  
pour tuyau Ø 4x6 mm**

E468151

**387042**

**Injecteur Ø 3 mm Ltot=33 mm  
fileté M10x1**

00324249000

00-324249-000

324249

## Electrovannes et Réducteurs

**376126**

**Electrovanne 180° - 1 voie - 230V 50/60Hz -  
Ø 10,5 mm**  
avec fastons; entrée Ø 3/4" avec filtre et  
entrée réducteur 5lt/min ; Tmax 90° C (RPE)

00883658001  
012461641  
883658-1

00-883658-001  
01-246164-1

01-246164-001  
8836581

**376113**

**Electrovanne 180° - 1 voie - 220/240V  
50/60Hz - Ø 10,5 mm**  
avec fastons; entrée Ø 3/4" avec filtre et  
entrée réducteur 15lt/min ; Tmax 90° C (RPE)

00883658002  
012461643  
883658-2

00-883658-002  
01-246164-3

01-246164-003  
8836582

## Electrovannes et Réducteurs

**390738**

**Electrovalve en laiton G3/4" 110/120V  
50/60Hz**  
bobine 9W 110/120V 50/60Hz

0027100200001  
271002-1

00-271002-00001

2710021

**388975**

**Electrovalve en laiton G1/2" 220/240V  
50/60Hz**  
L=95 mm; bobine 220/240V 50/60Hz 9,6W;  
membrane in PTFE; Psteam 2-50 PSI

0011209100002  
112091-2

00-112091-00002

1120912

**398467**

**Bobine 230V 50/60Hz**  
pour electrovalve 376114

00775530301  
775530-301

00-775530-301

775530301

**582098**

**Service KIT**  
pour electrovalve 388974 en 388975

00-114299

114299

**376125**

**Electrovalve 90° - 1 voie - 220/240V  
50/60Hz - Ø 14,5 mm**  
avec fastons; entrée Ø 3/4" avec filtre et  
reducteur - sortie Ø 14,5 mm

00324207001  
324207-1

00-324207-001

3242071

## Vannes sphériques, Raccords

**401009**

**Raccord cannelé 90° - G1/2"**

00299240001  
299240-1

00-299240-001

2992401

**339989**

**Raccord cannelé - sortie Ø 6 mm**  
L=28 mm; CH13

E468117

**376308**

**Raccord 90° Øest. 18 mm**

00883281001  
883281-1

00-883281-001

8832811

**376307**

**Raccord en T Ø 17,5 - 13,5 - 13,5 mm**  
dim. 80x40 mm

00324071000  
32407100-324071-000  
324071-1

00-324071-001

## Vannes sphériques, Raccords

**390600**

Raccord à Y Ø 10-10-10 mm

00174047002  
174047-2

00-174047-002

1740472

**390601**

Raccord en Y Ø 13-13-13 mm

00174047001  
174047-1

00-174047-001

1740471

**450850**

Raccord en Y Ø 12-12-12 mm

E143173

**389518**

Valve anti-réflux [KIT]

embout cannèle Ø 10,50; entrée/sortie Ø 22 mm

00883817002

00-883817-002

01-510300-001

01510300002

01-510300-002

015103001

01-510300-1

01510300-1

015103002

01-510300-2

01-51031

01-510552-001

01510552002

01-510552-002

015105521

01-510552-1

015105522

01-510552-2

8838172

883817-2

**376417**

Bouchon Ø 10 mm

00775531001  
775531-1

00-775531-001

7755311

**400346**

Valve anti-réflux 1/2" FF 180°F/125PSI

0029290900002  
292909-2

00-292909-00002

2929092

## Tuyaux

**407686**

Tuyau formé Ø 30x38x84 mm

00781335001  
781335-1

00-781335-001

7813351

**382800**

Tuyau formé [Kit]

raccords 45° Ø 30x38x84 mm; raccords 90° Ø 30x38 mm dim. 100x100 mm; agrafe de tuyau Ø 35-40 mm

00-781336-001  
7813361

00896964000

781336-1

00-896964-000

896964

**318526**

Tuyau formé 90° Ø int 49 mm

E127041

**404174**

Tuyau formé Ø 60x74 mm

dim. 235x200 mm

00898231002  
898231-2

00-898231-002

8982312

## Tuyaux

404115



Tuyau formé Ø 60x72 mm  
dim. 235x200 mm

00898333001  
898333-1

00-898333-001

8983331

387505



Tuyau d'aspiration Ø 110 mm  
dim. 155x175 mm

00229434000

00-229434-000

229434

387128



Tuyau formé  
dim. 180x130x30 mm; M24; CH 30

00300707000

00-300707-000

300707

200005



Tuyau en EPDM Ø 5x12 mm (vendu au  
mètre)

E143005

402829



Tuyau en EPDM Ø 5x12 mm L=1000 mm

00-139321-127  
139321127  
371450-173

00371450173  
139321-127

00-371450-173  
371450173

200002



Tuyau en EPDM Ø 12x19,5 mm (vendu au  
mètre)  
pour eau chaude - Pmax 10 bar - temp. de  
travail -35°C+120°C

E143010

404100



Tuyau EPDM Ø 16x27 mm L=715 mm

00898248001  
00-898248-002  
8982482

00-898248-001  
8982481  
898248-2

00898248002  
898248-1

399463



Tube Ø 4x7x2600 mm

00324402003  
324402-3

00-324402-003

3244023

376469



Tuyau en silicone Ø 10x15 mm L=1000  
mm

00774080001  
774080-1

00-774080-001

7740801

524404



Tuyau d'alimentation recouvert d'acier  
3/4" L=2000 mm DN13  
raccord droit + raccord coudé 90°; ecrou en  
laiton-nickel Ø 3/4" F; Pmax 25 bar; Tmax  
100°C; certifié WRAS

012403161

## Tuyaux

409539



Tuyau d'alimentation Ø 23x1050 mm

00883167003  
883167-3

00-883167-003

8831673

376219



Kit tuyau d'alimentation

tuyau flexible 3/4" 90°/180° L=1900 mm; tuyau EPDM Ø 10x16 mm L=1200 mm

00-775552-001  
00-895495-000  
01-246176-001  
01-246177-001  
7755521  
775552-2  
898045-100-775552-002  
00-898045-001  
012461761  
012461771  
775552-1  
895495  
898045400895495000  
00-898045-004  
01-246176-1  
01-246177-1  
7755522  
8980451  
898045-4

376485



Tuyau de vidange PPE Ø 19 mm 180° - Ø 19 mm 180° L=2100mm

raccords Øint./est. 19/25 mm; tuyau Øest. 25 mm

00324045000

00-324045-000

324045

438247



Tuyau de vidange PPE Ø 21 mm 180°+ Ø 30 mm M 180° L=2150 mm

raccords Øint/ext 21/28 mm et 30/34 mm, tuyau Øext 26,5 mm

00323801001  
003238011  
323801-100-323801001  
00-323801-100-323801-001  
3238011

700443



Tuyau de vidange PPE Ø 21,5mm 180°+ Ø 21,5mm 180° L=630 mm

raccords Øint/ext 21,5/26 mm, tuyau Øext 24 mm, Clean 3

E127037

700445



Tuyau de vidange PPE Ø 28 mm 180°+ Ø 24 mm 180° L=1500 mm

raccords Øint/ext 28/33 mm et 24/29 mm, tuyau Øext 29,5 mm

E143178

700444



Tuyau de vidange PPE Ø 22,5 mm 180°+ Ø 22 mm M 180° L=280 mm

raccords Øint/ext 22/27,5 mm, tuyau Øext 22,5 mm

E127044

376484



Tuyau de vidange PPE Ø 22 mm 90° + Ø 19 mm 180° L = 2000 mm

manchon 180° Ø int/ext 19/25 mm, 90° ext Øint/manche 22/28 mm, 25 mm tube Øext

00371450111  
00-883961-001  
01-243347-001  
371450111  
883961-100-371450-111  
00883961002  
012433471  
371450-111  
883961200883961001  
00-883961-002  
01-243347-1  
8839611  
883961-2



Traitement de l'eau

**398468**



**Adoucisseur 220/240V 50/60Hz**  
dim. 210x230x205 mm

00-775530-001	00775530002	00-775530-002
7755301	775530-1	7755302
775530-2		

**376082**



**Couvercle adoucisseur [KIT]**

00775530050	00-775530-050	77553050
775530-50		

**582130**



**Cartouche osmose inverse 1812 100GPD**  
avec 2 O-ring 2x14 mm

01294282101	01-294282-101
-------------	---------------

**459756**



**Cartouche carbone**  
H=275 mm

01-294225-001	012942251	01-294225-1
01-294225-101	12942251	1294225101

Composants de vidange

**404184**



**Collecteur de vidange Ø 155 mm**  
dim. 119x155x110 mm

00-898186-001	00898202001	00-898202001
00-898202-001	00898202002	00-898202-002
008982021	00-898202-1	8981861
898186-1	8982021	898202-1
8982022	898202-2	

**387509**



**Collecteur de vidange Ø 50x140 mm**

00229419000	00-229419-000	229419
-------------	---------------	--------

**390149**



**Bonde de vidange Ø 1" 1/2 H=20 mm**  
Øint. 41 mm

00226558001	00-226558-001	2265581
226558-1		

**409637**



**Tuyau de trop-plein avec filtre Ø 106 mm**  
Ltot.=350 mm; tuyau Øest. 35,5 mm

00883550004	00-883550-004	8835504
883550-4		

**399719**



**Tuyau de trop-plein avec filtre Ø 155 mm**  
Ltot.=460 mm; tuyau Øint.36/est.28 mm

00323534002	00-323534-002	00-774412-002
3235342	323534-2	7744122
774412-2		

**399702**



**Tuyau de trop-plein avec filtre Ø 155 mm**  
Ltot.=500 mm; tuyau Øint.28/est. 36 mm

00323534005	00-323534-005	3235345
323534-5		

## Composants de vidange

**322875**

**Tuyau de trop-plein avec filtre Ø 255 mm**  
Ltot.=465 mm; tuyau Øext. 36 mm

00323534006  
323534-6

00-323534-006

3235346

**389175**

**Tuyau de trop-plein Ø 51x370 mm**

0011909900002  
119099-2

00-119099-00002

1190992

**317525**

**Tuyau de trop-plein Ø 52x360 mm**

2294271  
229427-1V

229427-1

2294271V

**317534**

**Tuyau de trop-plein Ø 52x360 mm**

00230346002  
230346-2

00-230346-002

2303462

**403434**

**Tuyau de trop-plein Ø 22x168 mm**

E142051

## Filtres

**395284**

**Filtre 85x74 mm**

01245377001  
01-245377-1

01-245377-001

012453771

**394364**

**Filtre de cuve Ø 155 mm - H=115 mm [KIT]**

00-883578-001  
01-297817-001  
8835781  
883582-1

00-883582-001  
012978171  
883578-1

01297817001  
01-297817-1  
8835821

**394358**

**Anneau de filtre Ø 132,5x142,5x6,5 mm**

01297809001  
01-297809-1

01-297809-001

012978091

**387019**

**Filtre de cuve Ø 139xh80 mm**

00324768000

00-324768-000

324768

## Filtres

**409615**

Filtre de cuve Ø 140 mm L=80 mm

00883584001  
883584-1

00-883584-001

8835841

**409645**

Filtre de cuve Ø 157 mm

00883733001  
883733-1

00-883733-001

8837331

**398441**

Filtre Ø 115 mm H=22 mm

00775405001  
775405-1

00-775405-001

7754051

**403060**

Ecrou Ø 20,7x13 mm

E408006

**323930**

Filtre Ø 24x88/122xh68 mm

139321744

E121100

**450374**

Filtre Ø 153x120 mm

E121052

E121081

## Composant structuraux

380928



Protection 500x270x1 mm

00494213000

00-494213-000

494213

402716



Levier de vidange L=110 mm

00375215001  
375215-1

00-375215-001

3752151

## Doigt transporteur

386579



Rouleau Ø 10x20x25x24,50 mm

00296638000

00-296638-000

296638

402745



Roller

00-375870-000  
37587000375870001  
375870100-375870-001  
375870-1

402085

Came L=95 mm  
FRONT R to L - REAR L to R0043670400001  
436704-1

00-436704-00001

4367041

402125

Came L=95 mm  
FRONT L to R - REAR R to L0043670400002  
436704-2

00-436704-00002

4367042

## Thermomètres

402133

Thermometre Ø 52 mm 40÷105°C  
bulbe Ø 11x66 mm; capillaire L=2450 mm;  
presse étoupe Ø 15,5 mm CH16 mm00-276923-00006  
2769236  
437041-30043704100003  
276923-600-437041-00003  
4370413

390292

Thermometre 30÷120°C  
bulbe Ø 8,6x35 mm; capillaire L=3000 mm; dim  
24,70x57,70 mm00-228720-002  
2287202  
228720-300228720003  
228720-200-228720-003  
2287203

## Composants mécaniques

402708



Circlip Ø 18,5/20x1,2

00372955001  
372955-100-372955-001  
QA011463729551  
QA011-46

402815



Circlip Ø 35x1,5 mm

00374960001  
374960-1

00-374960-001

3749601

## Composants mécaniques

**381454**

Circlip INOX Øest. 10,8x0,7 mm

00602950000  
RR-E-2-2700-602950-000  
RRE2-27

602950

**416014**

Circlip Ø 6x14xh0,9 mm INOX

00-604050-000  
RRE1-7

604050

RR-E-1-7

**376017**

Anneau Ø 41x46x3 mm

00775933001  
00-775933-003  
015153561  
7759331  
775933-300-775933-001  
01515356001  
01-515356-1  
775933-100775933003  
01-515356-001  
01515356-1  
7759333**378634**

Anneau Ø 60 mm

00324751000

00-324751-000

324751

**399647**

Amortisseur Ø 14xhtot.7 mm

00323785101  
323785-101

00-323785-101

323785101

**376408**

Tampon en caoutchouc Ø 9mm noir

00228828000  
00-228828-001  
228828-100-228828-000  
22882800228828001  
2288281**387462**

Bride bague Ø 8,5x12,8/16x8 mm

00229566000

00-229566-000

229566

**322753**

Bague Ø 7,2/14x22x30 mm - H=27 mm

00323743000

323743

**439006**

Clavette 6x6x25 mm - INOX

00298687002  
298687-2

00-298687-002

2986872

**381470**

Goupille Ø 1,6x14 mm

00602883000

00-602883-000

602883

## Composants mécaniques

381469



Goupille fendue Ø 2x20 mm

00602884000  
60288400-602884-000  
603460

00-603460-000

376083



Goupille fendue Ø 2,7x18mm

00602886000

00-602886-000

602886

383931



Goupille fendue 2,8x16 mm

Ltot.=25 mm

00603274000

00-603274-000

603274

438438



Ecrou hexagonal M6 autofreies - INOX

00602502000

00-602502-000

602502

322630

Ecrou hexagona M8x8 INOX  
indesserrable0016340900002  
163409200-163409-00002  
163409-200-602503-000  
602503

200250



Ecrou hexagonal M6 - H=5 mm INOX

00602491000

00-602491-000

602491

582965



Ecrou hexagona M8 - INOX

00-602492-000

602492

602492000

381706

Ecrou hexagona M8 - H=6,5 mm - fileté  
gauche

00601151000

00-601151-000

601151

387028

Ecrou hexagona M8 fileté droit-gauche  
L=60 mm  
CH13

00324707000

00-324707-000

324707

397192



Ecrou hexagona M32 - H=7,5 mm

00695664005  
695664-5

00-695664-005

6956645

## Composants mécaniques

390395



Erou hexagonal 1 1/8"

00172739003 00-172739-003 1727393  
172739-3

390396

Erou hexagonal 3/4" - H=4,5 mm  
CH30 mm

00172739002 00-172739-002 1727392  
172739-2

418034

Erou hexagonal borgne M6  
H=11,5 mm

00603036000 00-603036-000 603036

387434

Erou molette plate M6 Ø 25 mm H=3,5/6  
mm

00228644000 00-228644-000 228644

455560

Erou molette plate M10 Ø 25 mm H=4  
mm

E80697

376094

Erou molette plate M12x1 Ø 32 mm H=3  
mm

00-324036-000 01240205001 01-240205-001  
012402051 01-240205-1 324036

518655



Agrafe de tuyau Ø 40-60/9 mm - INOX

00-166513-003 1665133

582964

Collier de serrage plastique H=2,50 mm  
÷ L=160 mm

00165128001 00-165128-001 00-699734-387  
1651281 165128-1 699734387  
699734-387

395615



Collier de serrage Ø 7 mm H=8,66 mm

01246214003 01-246214-003 012462143  
01-246214-3 01-510143-001 015101431  
01-510143-1

409464



Bouchon Ø 35 mm

00883271001 00-883271-001 8832711  
883271-1

## Composants mécaniques

401518



Rouleau Ø 59,50 mm H=17,4 mm

00377373003  
377373-3

00-377373-003

3773733

403972



Rouleau chaîne Ø 50x34 mm

00-326121-001  
3261211  
897970-100897970001  
326121-100-897970-001  
8979701

376410



Bouchon Ø 10/15xh18 mm

00774512001  
774512-1

00-774512-001

7745121

382085



Guide L=140 mm

00375213000

00-375213-000

375213

395654

Bouchon Ø 72 mm  
filté M10x18 mm00-229585-000  
01248160101248160001  
01-248160-101-248160-001  
229585

385249



Plaque de fixation 54,4x15,3 mm

00142413000

00-142413-000

142413

325216



Plaque 25x84x2 mm

00898598001  
898598-1

00-898598-001

8985981

376365



Rondelle grower Ø 4,2 mm INOX

00602308000  
VC03209  
VC-32-900-602308-000  
VC032-09602308  
VC329

358211



Rondelle grower Ø 6,3 mm INOX

00602307000

00-602307-000

602307

432605

Rondelle plate M6 Ø 6,4x11,6x1,6 mm  
INOX00602286000  
60228600-602286-000  
603462

00-603462-000



## Composants mécaniques

**364457**

Rondelle plate Ø 8,5x16x1,5 mm INOX

00-602287-000  
602287000  
WAME8-3600-603617-000  
603617602287  
WAM-E-8-36**322015**

Rondelle plate M10 INOX

00602288000

00-602288-000

602288

**376020**

Rondelle plate Ø 14,90x19,70x0,5 mm - téflon

00774072001  
774072-1

00-774072-001

7740721

**376019**

Rondelle plate Ø 16x20,50x0,5 mm - téflon

00774072002  
774072-2

00-774072-002

7740722

**381424**

Goupille fendue Ø 8,70x50 mm

00602849000  
60284900-602849-000  
603545

00-603545-000

**522833**

Vis de fixation crantée M5x8 mm (10 pcs)

00609782000

00-609782-000

609782

**358124**

Vis tête hexagonale M8x20 mm - INOX

00-602577-000

602577

**381382**

Vis tête hexagonale M8x25 mm - INOX

00602976000  
00-699739-041  
699739-041  
SC411300-602976-000  
602976  
SC04113  
SC-41-1300699739041  
699739041  
SC-041-13**582729**

Vis à tête fendue M5x30 mm inox

SCME1236

SCM-E-12-36

**381681**

Vis M6x12 mm

00600699000  
60069900-600699-000  
602632

00-602632-000

## Composants mécaniques

## Collier de serrage avec vis



<b>376136</b>	Ø 17 mm	<b>323945-40</b>	<b>376138</b>	Bifilaire	Ø 21,50 mm	<b>323945-21</b>
<b>376140</b>	Ø 29 mm	<b>323945-29</b>	<b>399773</b>	Bifilaire	Ø 23 mm	<b>323945-22</b>
<b>376141</b>	Ø 34 mm	<b>323945-33</b>	<b>399659</b>	Bifilaire	Ø 23,50 mm	<b>323945-23</b>
<b>376143</b>	Ø 37 mm	<b>323945-37</b>	<b>376139</b>	Bifilaire	Ø 25 mm	<b>323945-25</b>
<b>376144</b>	Ø 53 mm	<b>323945-53</b>	<b>399829</b>	Bifilaire	Ø 35÷40 mm	<b>323945-40</b>
<b>376145</b>	Ø 56 mm	<b>323945-56</b>	<b>376142</b>	Bifilaire	Ø 35 mm	<b>323945-35</b>
<b>376147</b>	Ø 64 mm	<b>323945-64</b>	<b>399827</b>	Bifilaire	Ø 50 mm	<b>323945-49</b>
<b>376135</b>	Bifilaire	Ø 15 mm	<b>399826</b>	Bifilaire	Ø 69 mm	<b>323945-68</b>
<b>376137</b>	Bifilaire	Ø 18 mm	<b>399824</b>	Bifilaire	Ø 78 mm	<b>323945-76</b>

## Collier de serrage bifilaire



<b>399494</b>	Ø 6,3+7 mm	<b>324510-73</b>	<b>399497</b>	Ø 27,00+31,80 mm	<b>324510-313</b>
<b>399494</b>	Ø 6,6+7 mm	<b>324510-81</b>	<b>399499</b>	Ø 22,00+23,70 mm	<b>324510-258</b>
<b>399493</b>	Ø 7,3+7,8 mm	<b>324510-86</b>	<b>399498</b>	Ø 25,00+27,00 mm	<b>324510-287</b>
<b>380343</b>	Ø 8,8+9,3 mm (5 pcs)	<b>324510-68</b>	<b>376133</b>	Ø 27,60+29,20 mm	<b>324510-327</b>
<b>399518</b>	Ø 14,8+15,9 mm	<b>324510-173</b>	<b>582968</b>	Ø 30,70+32,90 mm	<b>024510-356</b>
<b>376131</b>	Ø 17,7+18,7 mm	<b>324510-202</b>	<b>399496</b>	Ø 33,20+34,80 mm	<b>324510-341</b>
<b>399501</b>	Ø 19,7+20,6 mm	<b>324510-192</b>	<b>582967</b>	Ø 33,80+36,30 mm	<b>324510-388</b>
<b>376132</b>	Ø 21+23 mm	<b>324510-242</b>	<b>582966</b>	Ø 35,20+39,20 mm	<b>324510-429</b>

## Coussinets

**341601**

Palier à billes Ø 8x22x7 mm

00301302010	00-301302-010	0030130210
00-301302-10	301302010	301302-010
30130210	301302-10	

**334397**

Palier à billes Ø 10x26x8 mm

00-301302-015	30130215
---------------	----------

**389545**

Plaque tournante de roulement Ø 12x40 mm filetage M6 gauche

01510556002	01-510556-002	015105562
01-510556-2	04005530004	04-005530-004
040055304	04-005530-4	

**389546**

Plaque tournante de roulement Ø 12x40 mm filetage M6 droite

01510556001	01-510556-001	015105561
01-510556-1	04-005530-003	04-005530-3

## Joint axe

**412354**

Joint d'étanchéité Ø 24x12x16 /  
contre-joint Ø 26x12x8 mm  
Joint d'étanchéité en TEFLON

E141007

## Fermetures

**452776**

Plaque de glissement  
dim. 19x88xh10 mm

E307003

**376229**

Aimant Ø 5x34x17 mm

00-325673-001	00774714001	00-774714-001
3256731	325673-1	7747141
774714-1		

**385097**

Aimant Ø 23x11 mm

00166964000	00-166964-000	166964
-------------	---------------	--------

## Fermetures

**392415**

**Aimant avec support [KIT]**  
aimant 20x10x5 mm

01-240293-001	012402931	01-240293-1
01-240294-001	012402941	01-240294-1
01240295001	01-240295-001	012402951
01-240295-1		

**398237**

**Aimant 24x12x10 mm**

00775860001	00-775860-001	7758601
775860-1		

**389454**

**Aimant support 23,5x28x14,3 mm**

01510648001	01-510648-001	015106481
01-510648-1		

**409640**

**Aimant support 24x12 mm**  
dim. 24x12 mm

00883746001	00-883746-001	8837461
883746-1		

**394740**

**Aimant support 24,5x45/61x12,5 mm**

01297033001	01-297033-001	012970331
01-297033-1		

## Surchauffeurs

**456092**

**Surchauffeur 3 résistances**  
dim. Ø 250x460 mm

E927067

**319262**

**Surchauffeur 3 résistances [KIT]**  
dim. Ø 168x450 mm; avec isolant

00323773001	00-323773-001	00-886762-001
3237731	323773-1	8867621
886762-1		

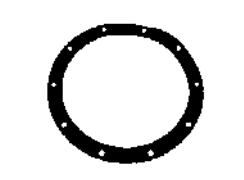
**376192**

**Joint surchauffeur Ø 215x265x2 mm**

00230994000	00-230994-000	230994
-------------	---------------	--------

## Ressort

409210



Ressort 84x50 mm

00895644001  
895644-1

00-895644-001

8956441

410046

Ressorts de compression Ø 8,10 mm  
L=65 mm00886839001  
886839-1

00-886839-001

8868391

387025



Ressorts de compression Ø 37x14 mm

00324730000

00-324730-000

324730

382094

Ressort de élévation L=65 mm Ø 52,00  
mm, mod. UW 120,125  
UW/UWX

00378590000

00-378590-000

378590

376240

Ressort de élévation L=65 mm Ø 56,00  
mm, mod. UW 50,120,200  
UW/UWX00-299110-000  
29911000378591000  
378591

00-378591-000

387390

Ressort de traction Ø 11,5x57xLtot.97  
mm  
fil Ø 1,4 mm

00228289000

00-228289-000

228289

387017



Ressorts de traction Ø 20x180x240 mm

00324773000

00-324773-000

324773

395632

Ressorts de traction Ø 22,5x135xLtot180  
mm  
fil Ø 2,5 mm01246079001  
01-246079-1

01-246079-001

012460791

386861



Ressorts de traction Ø 23x250 mm

00323722000

00-323722-000

323722

395069

Support ressort Ø 66x32 mm  
Ø int. 10/est. 54,5/66 mm H=32 mm01245280001  
01-245280-1

01-245280-001

012452801

## Ressort

**383434****Support ressort [KIT]**

dim. 10x30x50 mm; avec axe, rondelle en  
goupille

00-173481-000  
173481

00897920000  
897920

00-897920-000

**400083****Axe ressort de élévation Ø 8x47 mm**

00326089001  
326089-1

00-326089-001

3260891

**381425****Axe ressort de élévation Ø 10x70 mm**

trous Ø 3,3 mm

00602839000

00-602839-000

602839

## Photocellule

**388462**

**Réflecteur photocellule Ø 29x6 mm [KIT]**  
vis M3 L=8 mm; rondelle Ø 3,7x19,7x0,8 mm

00887031002  
01537791001  
01-537791-1  
887031-2

00-887031-002  
01-537791-001  
01537791-1

00-887031-2  
015377911  
8870312

**397232**

**Cellule photoelectrique VT18-204470**  
DC 10-230V; temperatura di lavoro  
-25°C....+70°C; connettore M12;4-pin

00695674010  
695674-10

00-695674-010

69567410

**400821**

**Récepteur photocellule**  
dim. 35x19.9x12/6 mm; câble L= 5000 mm

00301763006  
301763-6

00-301763-006

3017636

**400822**

**Récepteur photocellule**  
câble L=5000 mm

00301763005  
301763-5

00-301763-005

3017635

**408817**

**Récepteur photocellule**  
dim. 15x47x33 mm

00-887031-001  
8870311

00887178001  
887031-1

00-887178-001

## Platines

**315530**

**Platine électronique**  
K500/500P - ST330/330H

E215029

E215038

**316865**

**Platine électronique (sans processeur)**  
GL71/72/71 - GS55/77 - GOLD43 - LP201 -  
SV71/72

E215023

**Platines**

**376374**



**Platine électronique (sans eeprom)**

- |               |               |               |
|---------------|---------------|---------------|
| 00-897502-002 | 00-897502-012 | 00-897502-015 |
| 00-897502-022 | 00-897502-117 | 00-897502-217 |
| 8975021       | 897502117     | 897502-117    |
| 89750212      | 897502-12     | 89750215      |
| 897502-15     | 8975022       | 897502-2      |
| 897502217     | 897502-217    | 89750222      |
| 897502-22     |               |               |

**316869**



**Carte électronique (sans eeprom)**

dim: 145x125 mm - AMX / AUX / FX/GX & FP/GP / ECOMAX 402-602 / GC / GCP

- |               |               |               |
|---------------|---------------|---------------|
| 00897545001   | 00-897545-001 | 00-897545-002 |
| 00897545003   | 00-897545-003 | 00897545201   |
| 00-897545-201 | 897545-002    | 8975451       |
| 897545-1      | 8975452       | 897545-2      |
| 897545-201    | 8975453       | 897545-3      |

**404411**



**Carte électronique d'extension**

dim. 70x120 mm

- |               |             |               |
|---------------|-------------|---------------|
| 00-897546-001 | 00897546002 | 00-897546-002 |
| 00-897546-003 | 00897546202 | 00-897546-202 |
| 8975461       | 897546-1    | 8975462       |
| 897546-2      | 897546-202  | 8975463       |
| 897546-3      |             |               |

**376378**

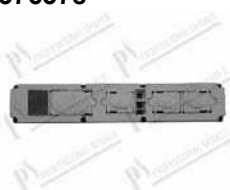

**Carte interface utilisateur**

CNA / UX / UXL / AUX

- |             |               |         |
|-------------|---------------|---------|
| 00897501001 | 00-897501-001 | 8975011 |
| 897501-1    |               |         |

**378625**



**Carte interface utilisateur 183x45 mm**

- |               |               |               |
|---------------|---------------|---------------|
| 00-897540-001 | 00-897540-002 | 00897540201   |
| 00-897540-201 | 00897540202   | 00-897540-202 |
| 8975401       | 897540-1      | 8975402       |
| 897540-2      | 897540-201    | 897540-202    |

**409595**



**Capteur manque de dosage**

dim. 57x57 mm

- |             |               |         |
|-------------|---------------|---------|
| 00883930001 | 00-883930-001 | 8839301 |
| 883930-1    |               |         |

**321309**



**Eeprom FW rev.10.4**

- |             |               |         |
|-------------|---------------|---------|
| 00897503002 | 00-897503-002 | 8975032 |
| 897503-2    |               |         |

**582574**



**Eeprom FW rev.0.7**

- |          |           |
|----------|-----------|
| 89750317 | 897503-17 |
|----------|-----------|



**Platines**

**325608**



**Eprom Rev. 2.3/DD01**

00-897547-012

897547-12

**390328**



**Câble chart**

L=325 mm; puntale Ø 1,2x1,7 mm

00227073090  
227073-90

00-227073-090

22707390

**408149**



**Câble nappe F/F 10B L=1740 mm**

00785446001  
7854461  
785446-4

00-785446-001  
785446-1

00-785446-004  
7854464

**408466**



**Connecteur 3 phases**

00785429016  
785429-16

00-785429-016

78542916

**408465**



**Connecteur 3 phases**

00785429019  
785429-19

00-785429-019

78542919

**Sondes**

**376064**



**Clip de fixation sonde de température**  
dim. 24,5x35x5 mm

00-324157-000  
324157

00775489001  
7754891

00-775489-001  
775489-1

**398058**



**Sonde de température NTC**

bulbe Ø 4,7x35,5 mm; câble L=250 mm

00775612002  
775612-2

00-775612-002

7756122

**316825**



**Sonde de température NTC**

bulbe Ø 5x30 mm; câble L= 390 mm; INOX à partir de -40 a +110°C, avec raccord

E231014

E231016

**376388**



**Sonde de température NTC**

bulbe Ø 5x30 mm, câble L=265 mm

00-738455-000  
738455

00775612001  
7756121

00-775612-001  
775612-1

**Membranes**

**384508**



**Membrane adhésive 170/150x80 mm**  
UX60

00774052000

00-774052-000

774052

**404379**



**Membrane adhésive 500x40 mm**  
UX / UXL / UXT / UXTL

00897500001  
897500-1

00-897500-001

8975001

**Joint s pour lave-vaisselle**

**318200**



**Joint de porte PVC L=1090 mm  
UXT / UPT**

00302207006  
302207-6

00-302207-006

3022076

**390856**



**Joint de porte L=1500 mm  
ECOMAX 700**

00229169004  
229169-4

00-229169-004

2291694

**Joint s plats**

**391746**



**Joint en fibre Ø 17x24x2 mm**

00168611009  
168611-9

00-168611-009

1686119

**376176**



**Joint plate Ø 6x12x3 mm**

00324594000

00-324594-000

324594

**390428**



**Joint plate Ø 21x30x2 mm**

00172986003  
172986-3

00-172986-003

1729863

**376175**



**Joint plate Ø 25,5x34x2,5 mm pour  
chambre air**

00775305001  
775305-1

00-775305-001

7753051

**376170**



**Joint plate Ø 47x60x0,9 mm**

00172986019  
172986-19

00-172986-019

17298619

**376179**



**Joint plate Ø 59x71x2/6 mm**

00172 986022  
00-172986-022  
17298622

00-172 986-022  
172986022  
172986-22

00172986022  
172986-022

**390424**



**Joint plate Ø 60x70x1,9 mm**

00172986039  
172986-39

00-172986-039

17298639

**376172**



**Joint plate Ø 61x71x1,6 mm**

00172986035  
172986-35

00-172986-035

17298635

## Joints plats

**397869**

Joint plate Ø 10,50x15x1,65 mm - Teflon

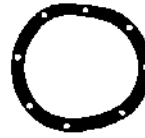
00-168611-017  
16861117  
774072-300774072003  
168611-1700-774072-003  
7740723**387458**Joint Ø 210x260x2,3 mm  
trous Ø 13 mm

00229586000

00-229586-000

229586

**319348**

Joint adhésif 12x2 mm [20 Mt]

00168834006  
168834-6

00-168834-006

1688346

## O-ring



<b>376247</b>	1,50x6,00 mm	VITON	<b>276903-55</b>	<b>435178</b>	3,53x20,22 mm	VITON	<b>06750-72</b>
<b>373031</b>	1,78x5,28 mm	EPDM	<b>E456009</b>	<b>416272</b>	3,53x23,40 mm	SILICONE	<b>67500-11</b>
<b>337127</b>	1,78x9,25 mm	NBR	<b>E456019</b>	<b>438162</b>	3,53x28,17 mm	VITON	<b>67500-12</b>
<b>456112</b>	1,78x28,30 mm	EPDM	<b>E927094</b>	<b>373114</b>	3,53x47,53 mm	EPDM	<b>276903-21</b>
<b>376250</b>	2,00x24,00 mm	VITON	<b>276903-50</b>	<b>456115</b>	3,53x50,80 mm	EPDM	<b>E927097</b>
<b>438736</b>	2,62x15,54 mm	NBR	<b>609009</b>	<b>400902</b>	5,34x37,47 mm	VITON	<b>303117-1</b>
<b>376254</b>	3,00x25,00 mm	VITON	<b>276903-56</b>	<b>438465</b>	5,34x37,47 mm	EPDM	<b>67500-150</b>
<b>434029</b>	3,00x28,00 mm	EPDM	<b>276903-9</b>	<b>612335</b>	5,34x43,82 mm (3 pcs)	VITON	<b>233982-6</b>
<b>376256</b>	3,00x83,00 mm	EPDM	<b>775465-11</b>	<b>435303</b>	5,34x46,99 mm	NBR	<b>6750081</b>
<b>392404</b>	3,00x143,00 mm		<b>01-240272-001</b>	<b>376261</b>	5,34x47,00 mm	VITON	<b>01-240135-011</b>
<b>379455</b>	3,50x34,00 mm	EPDM	<b>139321-192</b>	<b>435067</b>	5,34x56,52 mm	NBR	<b>67500-118</b>
				<b>453928</b>	5,34x136,50 mm	EPDM	<b>E456076</b>



# **Machine Avancement Automatique**

**Composants Electriques**

**Composants Eau**

**Composants Mécaniques**

**Composants électroniques**

**Composants de réfrigération**

**Joints**

## Interrupteurs, Boutons, Sélecteurs

**394278**

**Bouton d'arrêt d'urgence decoupé Ø 22 mm - teté Ø 40xh40 mm**  
1 contact NC

01291707001  
01-291707-1

01-291707-001

012917071

**376425**

**Bouton d'arrêt d'urgence decoupé Ø 22 mm - teté Ø 38 mm**  
sans contact

00887015025  
887015-25

00-887015-025

88701525

**383600**

**Sectionneur principal [KIT]**  
dim. 69x120x80 mm

00695530000

00-695530-000

695530

**400801**

**Sectionneur principal [KIT]**  
100A 220/690V; extension Ø 8,50xLtot 215 mm

00301773001  
301773-1

00-301773-001

3017731

**400809**

**Sectionneur principal [KIT]**  
100A 220/690V; extension Ø 8,50xLtot 215 mm

00301773005  
301773-5

00-301773-005

3017735

**376071**

**Sectionneur principal [KIT]**  
100A 220/690V; extension Ø 8,5xLtot 80 mm

00785574006  
785574-6

00-785574-006

7855746

**410109**

**Poussoir lumineux double O-I Ø 22 mm - instable**  
dim. 30x55 mm; sans contacts

00887015040  
887015-40

00-887015-040

88701540

**393006**

**Poussoir double O-I Ø 22 mm**  
dim. 30x50 mm; sans contacts

00-738650-001  
00740522-1  
7405221

00740522001  
7386501

00-740522-001  
738650-1

**398529**

**Support**  
dim. 106x106x42,5 mm

00734115002  
734115-2

00-734115-002

7341152

**398528**

**Support**  
dim. 106x106 mm

00734115003  
734115-3

00-734115-003

7341153

## Interrupteurs, Boutons, Sélecteurs

**410025**

**Selecteur lumineux Ø 22 mm - 2 pos. 0-1 fixé**  
senza contatti ausiliari

00887015061  
887015-61

00-887015-061

88701561

**376383**

**Selecteur Ø 22 mm - 3 pos. 1-0-2 fixé**  
sans contacts auxiliaires

00887015071  
887015-71

00-887015-071

88701571

**410081**

**Selecteur Ø 22 mm - 2 pos. 0-1 fixé**  
sans contacts auxiliaires

00887015090  
887015-90

00-887015-090

88701590

**200303**

**Poussoir rouge Ø 22/28,5 mm - sans contacts**

00749992

00-749992

749992

**200302**

**Poussoir vert Ø 22/28,5 mm - sans contacts**

00892001

00-892001

892001

**410130**

**Poussoir rouge Ø 22 mm - instable**  
sans contacts auxiliaires

00887015021  
887015-21

00-887015-021

88701521

**376426**

**Poussoir lumineux vert Ø 22 mm - instable**  
sans contacts auxiliaires

00887015033  
887015-33

00-887015-033

88701533

**410144**

**Poussoir vert Ø 22 mm**  
sans contacts auxiliaires

00887015022  
887015-22

00-887015-022

88701522

**402613**

**Capuchon bouton poussoir 23x24 mm**

00374331001  
374331-1

00-374331-001

3743311

**376424**

**Bouton 27x27xH35 mm**

00324266001  
324266-1

00-324266-001

3242661

**Interrupteurs, Boutons, Sélecteurs**

**397964**



**Groupe contacts 250V 6(4)A**  
dim. 22,2x22,2x26 mm; faston 2,8x0,8 mm

00774793005      00-774793-005      7747935  
774793-5

**376228**



**Lentille "Horloge"**  
dim. 16,5x16,5 mm

00324265001      00-324265-001      3242651  
324265-1

**410089**



**E'tiquette vidange et remplissage**  
dim. 18x27 mm

00887016027      00-887016-027      88701627  
887016-27

**410147**



**Bloc de contact**  
dim. 41x30 mm

00738650002      00-738650-002      00887015012  
00-887015-012      7386502      738650-2  
88701512      887015-12

**399073**



**Contact auxiliaire NO avec bride**

0074998600004      00-749986-00004      7499864  
749986-4

**399089**



**Contact auxiliaire NC avec bride**

0074998600003      00-749986-00003      7499863  
749986-3

**410151**



**Contact auxiliaire NO**

00738650004      00-738650-004      00887015001  
00-887015-001      7386504      738650-4  
8870151      887015-1

**410146**



**Contact auxiliaire NC**

00738650003      00-738650-003      00887015002  
00-887015-002      7386503      738650-3  
8870152      887015-2

**Lampes et Carters de Lampe**

**410039**



**Voyant LED blanc 85-264V 50/60Hz**  
5-15mA

00887015045      00-887015-045      88701545  
887015-45



## Contacteurs et Relais

**391087****Contacteur 100-K09KF10**

3kW 3P; 230/240V 50/60Hz; 4kW 400V 50/60Hz; 3 cont. NO + 1 aux NO; dim. 53x45x54 mm

00-141440-001	00141440002	00-141440-002
00740520001	00-740520-001	1414401
141440-1	1414402	141440-2
740520-001		

**397358****Contacteur LC1K0610U7**

1,5kW 3P; 220-230V 50/60Hz; 2,2kW 380-415V 50/60Hz; 3 cont. NO + 1 aux. NO - dim. 57x45x58 mm

00493524003	00-493524-003	00493524005
00-493524-005	00695521011	00-695521-011
00695521012	00-695521-012	4935243
493524-3	4935245	493524-5
69552111	695521-11	69552112
695521-12		

**397353****Contacteur LC7K0601M7**

1,5kW 3P; 220/230V 50/60Hz; 2,2kW 380/415V 50/60Hz; 3 cont. NO + 1 aux NC

00695521041	00-695521-041	69552141
695521-41		

**376077****Contacteur LC1K0601M7**

1,5kW 3P; 220/230V 50/60Hz; 2,2 kW 380/415V 50/60Hz; 3 cont. NO + 1 aux NC

00-232478-001	00695521001	00-695521-001
00695521002	00-695521-002	00-695521-1
00-699734-637	2324781	232478-1
6955211	695521-1	6955212
695521-2	699734637	699734-637

**397547****Contacteur LC1D09P7**

2,2kW 3P; 220/230V 50/60Hz; 4kW 380/400V 50/60Hz

00153275001	00-153275-001	00153275020
00-153275-020	00174973002	00-174973-002
00695527001	00-695527-001	00695527002
00-695527-002	00699734626	00-699734-626
00844957001	00-844957-001	1532751
153275-1	15327520	153275-20
1749732	174973-2	6955271
695527-1	6955272	695527-2
699734626	699734-626	8449571
844957-1		

**409701****Relais 2P 120Vac**

20A 400Vac; faston 6,3x0,8 mm

000877140421	00-087714-042-1	87714421
87714-42-1		

**396914****Relais temporisé 3-300 sec. 220-240V**

**50/60Hz**  
dim. 80x22x78 mm

00493530001	00-493530-001	4935301
493530-1		

## Microinterrupteurs

**376203**

**Interrupteur fin de course 1NO/1NC L=71 mm**  
dim.57x51x30 mm

00785286001  
785286-1

00-785286-001

7852861

**376208**

**Interrupteur fin de course 1NO/1NC L=93 mm**

00226916000

00-226916-000

226916

**376214**

**Microinterrupteur magnétique Ø 5,6x25,5 mm**  
câble L=330 mm

01240288001  
01-240288-1

01-240288-001

012402881

**384291**

**Microinterrupteur magnétique M8x0,75 L=42 mm**  
1 NO, 200Vdc/250Vac 1A 50W; câble L=310 mm

00-738942-000  
738942

00740173000  
740173

00-740173-000

**435219**

**Microinterrupteur magnétique**  
NO contact 250V 50VA 0,04A - passo 5

00775491001  
775491-1

00-775491-001

7754911

**387538**

**Microinterrupteur magnétique 100VA**  
**0,2A 250Vac/dc IP67**  
1 NO; câble L=1300 mm

00229517000

00-229517-000

229517

**376213**

**Microinterrupteur magnétique 100VA**  
**0,2A 250Vac/dc IP67**  
1 NO; câble L=3900 mm

00229517002  
229517-2

00-229517-002

2295172

**408438**

**Microinterrupteur magnétique**  
dim. 80x30x15 mm; câble L=4200 mm

00785287001  
785287-1

00-785287-001

7852871

**322740**

**Interrupteur à flotteur**  
flotteur raccord 1/8", câble L = 1500

00-784845-001  
ML74969

7848451

784845-1

**404634**

**Interrupteur à flotteur Ø 9,5x52 mm**  
raccord 1/4"; câble L=130 mm

0093654700001  
00-936547-3  
936547-3

00-936547-00001  
9365471

00-936547-003  
936547-1

## Microinterrupteurs

382063



**Interrupteur à flotteur Ø 9,5x63,5 mm**  
raccord 1/4"; câble L=135 mm

00-328486	00328486000	00-328486-000
00328495	00-328495	328486-000
328495		

394621



**Interrupteur Ø 12x57 mm + NTC**  
raccord 1/4"; câble L=200 mm

01296000001	01-296000-001	012960001
01-296000-1		

390164



**Interrupteur Ø 12x57 mm**  
raccord 1/4"; câble L=2000 mm

00-226282-011	00226282012	00-226282-012
22628211	226282-11	22628212
226282-12		

376209



**Interrupteur Ø 12x57 mm**  
raccord 1/4"; câble L=2000 mm

00-226282-000	00226282002	00-226282-002
226282	226282	226282-2

376205



**Interrupteur à flotteur Ø 12x57 mm + PTC**  
raccord 1/4"

00229519000	00-229519-000	01-245621-001
012456211	01-245621-1	229519
ML102826		

394857



**Interrupteur à flotteur Ø 12x57 mm + NTC**  
raccord 1/4"; câble L=200 mm

01245621002	01-245621-002	012456212
01-245621-2		

394856



**Interrupteur à flotteur Ø 12x57 mm**  
raccord 1/4"; câble L=2000 mm

01245621003	01-245621-003	012456213
01-245621-3		

376164



**Flotteur avec aimant Ø 45 mm H=33 mm**  
dim: 60x48x33 mm

00122674	00-122674	00122674000
00-122674-000	122674	

384849



**Charniere pour flotteur**  
dim: 20x29x1.5 mm

00112467	00-112467	00112467000
00-112467-000	112467	

378614



**Interrupteur à flotteur Ø 18x64 mm**  
câble L=3500 mm; filetée M16

00735171002	00-735171-002	7351712
735171-2		

## Microinterrupteurs

**383410**

**Interrupteur à flotteur Ø 18x64 mm**  
câble L=3500 mm; fileté M16 - avec connecteur

00-735171-003  
7351713

00897968000  
735171-3

00-897968-000  
897968

**397885**

**Bride pour flotteur 434975**  
Ø 16x61x4 mm; trous Ø 6 mm

00774010001  
774010-1

00-774010-001

7740101

**397881**

**Joint Ø 24x52,5x4 mm**  
trous Ø 4,5 mm

00774034001  
774034-1

00-774034-001

7740341

**376399**

**Support aimant**

00883838001  
883838-1

00-883838-001

8838381

## Pressostats

**451289**

**Pressostat 1 niveau 90/56 mbar**  
contact capacité 16A 250V; Tmax 85°C

E224005

**390807**

**Pressostat 3 niveau**  
145/120-260/230-385/350 mbar

00231981005  
231981-5

00-231981-005

2319815

**394712**

**Pressostate LP 22 bar / HP 33 bar**  
8(5)A 400V - 16(10)A 400V

00-323449-000  
012967041

01296704001  
01-296704-1

01-296704-001  
323449

## Ventilateurs

**397699**

**Ventilateur axial Ø 300 mm 130/190W**  
230V 50/60Hz  
1400/1600 rpm

00774949002  
01-537205-2

00-774949-002  
7749492

01-537205-002  
774949-2

**398366**

**Ventilateur axial Ø 320 mm 120/170W**  
230/400V 50/60Hz

00-775078-001  
7750781

01537206001  
775078-1

01-537206-001

## Ventilateurs

398365



**Ventilateur axial Ø 350 mm 190/280W**  
**230/400V 50/60Hz**  
 1390/1580 rpm

00-775079-001  
 7750791

01537207001  
 775079-1

01-537207-001

322805



**Ventilateur axial Ø 320 mm 120/170W**  
**230V 50/60Hz**

00-781492-001  
 01518160001  
 015181601  
 7814921  
 781492-2

00-781492-002  
 01-518160-001  
 01-518160-1  
 781492-1  
 7814923

00-781492-003  
 01-518160-003  
 01-518160-3  
 7814922  
 781492-3

395031



**Support ventilator 315x315 mm**

01245747001  
 01-245747-1

01-245747-001

012457471

320433



**Ventilateur tangential Ø 80x242 mm; 32W**  
**230V 50Hz**  
 faston 6,3x0,8 mm

00231747001  
 2317471

00-231747-001  
 231747-1

23174701

378602



**Ventilateur tangential 420/760W 230/400V**  
**50/60Hz**  
 810W 265/400V 60Hz - Ø 210x320 mm  
 Ltot=380 mm

00897700002  
 897700-2

00-897700-002

8977002

582300



**Ventilateur tangential 3 phases**  
**1450/1650W 230/400V 50/60Hz**  
 4,7/2,7A, 1240/1440rpm; prestation 290x160 mm, aspiration Ø 280 mm, câble L=1100 mm

00868903001  
 868903-1

00-868903-001

8689031

320071



**Ventilateur tangential 3 phases 1950W**  
**230/400V 5,9/3,4A 50Hz**  
 prestation 380x160 mm, aspiration Ø 240 mm,  
 câble L=1300 mm- dim.380x450 mm

00868902001  
 8689021  
 868902-2

00-868902-001  
 868902-1

00-868902-002  
 8689022

## Fusibles, Condensateurs, Filtres RFI

311818



**Condensateur de mise en phase 4µF**  
**450V 50/60Hz**  
 Ø 30x71 mm; avec vis M8 et ecrou

00226568002  
 226568-2

00-226568-002

2265682

418004



**Condensateur de mise en phase 5µF**  
**400V 50/60Hz**  
 Ø 30x51 mm; avec vis M8

00226568009  
 226568-9

00-226568-009

2265689

## Fusibles, Condensateurs, Filtres RFI

**332311**

**Condensateur de mise en phase 10 µF**  
**400/450V 50/60Hz**  
 Ø 30x71 mm; ecrou M8

00226568010      00-226568-010      22656810  
 226568-10

**344792**

**Condensateur de mise en phase 16µF**  
**450V 50/60Hz**  
 Ø 30x71 mm; avec vis M8

00226568013      00-226568-013      00-232210-001  
 22656813      226568-13      2322101  
 232210-1      E206004

**390145**

**Condensateur de mise en phase 8µF**  
**400V 50/60Hz**  
 Ø 30x82 mm; avec vis M8

00139321009      00-139321-009      00-226568-014  
 00226568017      00-226568-017      00844956000  
 00-844956-000      139321-9      22656814  
 226568-14      844956

**315350**

**Fusible Ø 5x20 mm 0,50A 250V rapidee**

00785539027      00-785539-027      69561511  
 695615-11      78553927      785539-27

**435516**

**Fusible Ø 5x20 mm 0,25A 250V retardé**

00300099003      00-300099-003      300099-03  
 3000993      300099-3

**312599**

**Fusible Ø 5x20 mm 1A 250V retardé**

00785539070      00-785539-070      6956152  
 695615-2      78553970      785539-70

**397484**

**Fusible Ø 5x20 mm 1,6A 250V retardé**

00695615003      00-695615-003      00785539072  
 00-785539-072      6956153      695615-3  
 785539-072      78553972      785539-72

**451463**

**Fusible Ø 5x20 mm 4A retardé**

E228010

**320007**

**Fusible Ø 5x20 mm 6,3A 250V retardé (10 pz)**

00785539078      00-785539-078      78553978  
 785539-78

**376162**

**Fusible Ø 6,3x32 mm 0,8A 250V rapidee**

00775570002      00-775570-002      7755702  
 775570-2

## Fusibles, Condensateurs, Filtres RFI

376163



Fusible Ø 6,3x32 mm 6,3A 250V rapidee

00-152480-022  
15248022  
775570-100775570001  
152480-2200-775570-001  
7755701

393748



Fusible 250mA 250V retardé

0091478200009  
00-914782-009

00-914782-00009

00914782009

## Moteurs

391859



**Moteur 3 phases 180W 240/415V 1,2/0,7A**  
axe Ø 14x41 mm; clavette 5x30 mm; avec vis  
TE 6x16 mm; 1380/1680rpm

00145075006  
145075-6

00-145075-006

1450756

390688



**Motor 3 phases 550W 380/220V 50Hz**  
axe Ø 16/12x80 mm; fileté M10; dim.  
210x270x200 mm

00229741001  
229741-1

00-229741-001

2297411

400611



**Motor 3 phases 740W 200-240/380-416V  
50Hz**  
axe Ø 16x46 mm

0027423000008  
274230-8

00-274230-00008

2742308

376245



**Moteur 3 phases 1500W 220-240/380-415V  
50/60Hz**  
axe Ø 22 mm; fileté M12 L=16 mm

00324818034  
324818-34

00-324818-034

32481834

392647



**Moteur 3 phases 1500/1800W 220/415V  
50/60Hz**  
axe Ø 16 mm; filetto M10 L=10 mm

01245176007  
01-245176-701-245176-007  
04001250007012451767  
04-001250-7

378624



**Moteur 3 phases 2200/2600W  
220-240/380-418V 8,0/4,6A 50/60Hz**  
axe Ø 12/16 mm Ltot.=79 mm; 2850/3500rpm

00229136017  
22913617  
229136-2100-229136-017  
229136-1700-229136-021  
22913621

392601



**Moteur 3 phases 2200/2600W  
220-240/380-415 50Hz 8/4,6A**  
axe Ø 16/20xLtot.59 mm; fileté M10; clavette  
5x15 mm

01245176013  
01-245176-1301-245176-013  
040012500130124517613  
04-001250-013

392599



**Moteur 3 phases 2200/2600W 200/346V  
50Hz 9,4/5,4 A**

01245176016  
01-245176-16

01-245176-016

0124517616

## Moteurs

**392600**

**Moteur 3 phases 2600W 220-240/380/415V  
60Hz**  
axe Ltot. 61 mm; filetage M10

01245176014  
01-245176-14

01-245176-014  
04-001250-014

0124517614

**391822**

**Motoréducteur 3 phases 90W 50Hz  
230/415V**  
110W 440/460V 60Hz; axe Ø 20 mm L=45 mm;  
clavette 6x40 mm

00154792002  
00-887040-004  
1547922  
887040-4

00-154792-002  
00-887040-4  
154792-2  
89543333

00887040004  
00-895433-033  
8870404  
895433-33

**396938**

**Motoréducteur 3 phases 120W/70W  
380/415V 440/480V 50/60Hz**  
axe Ø 20x45 mm

00494947003  
494947-3

00-494947-003

4949473

**395455**

**Motoréducteur 3 phases 250/290W  
230-400V 265-460V**  
pour axe Ø 20 mm

01291291007  
01-291291-7

01-291291-007

012912917

**400625**

**Anneau d'étanchéité Ø 18x37x14 mm**

0027422700002  
274227-2

00-274227-00002

2742272

**400624**

**Adaptateur Ø 40x165xh40 mm**

0027422700003  
274227-3

00-274227-00003

2742273

**401315**

**Helice Ø 236 mm 50Hz**  
pour axe Ø 14 mm

00038933009  
38933-9

00-038933-009

389339

**407850**

**Bride Ø 100 mm**  
axe Ø 17-20xLtot.168 mm

00781064004  
781064-4

00-781064-004

7810644

**405808**

**Service KIT**

ML102749

**385353**

**Joint Ø 16/43,5x66x35mm**

00154791000

00-154791-000

154791



**Moteurs**

**407912**



Joint Ø 50x88x2 mm

00-733032-001	00-781007-000	00781007001
00-781007-001	7330321	733032-1
781007	7810071	781007-1

**454275**



Bague inférieure Ø 25x51x51 mm  
filetage 1" 1/4

E60356

**456114**



Bague Ø 30x61,5x55 mm  
filetage 1" 1/4

E927096

**456110**



Rouleau Ø 16x30x30 mm

E927092

**456113**



Anneau d'étanchéité Ø 30x40x7 mm

E927095

**456116**



Rondelle plate Ø 42x60x2 mm - laiton

E927098

**456117**



Ecrou 1" 1/4 - laiton  
H=17 mm; CH50

E927099

**Pompes**

**376288**



Pompe de lavage 1 phase 240W 220/240V  
50/60Hz  
aspiration Ø 32 mm; sortie Ø 1"; C=5µF 400V

00781237001	00-781237-001	00-7812371
00-781237-1	00847136001	00-847136-001
00-8471361	00-847136-1	7812371
781237-1	7812371V	781237-1V
8471361	847136-1	

**408005**



Pompe de lavage 1 phase 290W 220/240V  
60Hz  
aspiration Ø 32 mm; sortie Ø 1"

00781237004	00-781237-004	7812374
781237-4		

## Pompes

378630



**Pompe de lavage 1 phase 590W 230V  
50Hz**  
aspiration Ø 51 mm; sortie F1"

00897662001  
897662-1

00-897662-001

8976621

404312



**Pompe de lavage 3 phases 460/470W  
200/346V 60Hz 1,5/0,9A**  
aspiration Ø 51 mm; sortie F1"

00897662007  
897662-7

00-897662-007

8976627

390903



**Pompe de rinçage 120W 230V 50Hz**  
avec joint 27x38x2 mm; raccord M42; C=2,5µF  
230V

00229060010  
229060-10

00-229060-010

22906010

408003



**Pompe de rinçage 1 phase 180W  
220/240V 50Hz 0,8A**  
aspiration Ø 32 mm; sortie M33

00781237007  
781237-7

00-781237-007

7812377

408000



**Pompe de rinçage 1 phase 240W  
220-240V 50Hz 1A**  
aspiration Ø 32 mm; sortie M33 Øint 19 mm

00781237010  
781237-10

00-781237-010

78123710

376287



**Pompe de rinçage 1 phase 270W  
220/240V 1,3A 50Hz - SX**  
aspiration Ø 32 mm; sortie Ø 1"; C=5µF 400V

00781237002  
781237-2

00-781237-002

7812372

376289



**Pompe de rinçage 3 phases 165W  
220/380V 0,86/0,5A 50/60Hz**  
aspiration Ø 32 mm; sortie Ø 1"

00-774908-008  
774908-108  
7749088

00-774908-108  
774908108V  
774908-8

774908108  
774908-108V

317324



**Pompe de rinçage 3 phases 550W  
220/380V 1,7A 50Hz**  
aspiration Ø 51 mm; sortie 1" F

00897662002  
897662-2

00-897662-002

8976622

397986



**Couvercle pour pompe de lavage**

00774620002  
774620-2

00-774620-002

7746202

395042



**Entrée pompe**  
dim. 185x125x90 mm

01245713001  
01-245713-1

01-245713-001

012457131

## Pompes

**395041**

**Entrée pompe**  
dim. 210x170x90 mm

01245713002 01-245713-002 012457132  
01-245713-2

**382818**

**Couvercle de pompe [KIT]**

00895447000 00-895447-000 01-245113-001  
012451131 01-245113-1 895447

**387031**

**Couvercle de pompe Ø 323 mm**  
sortie bride Ø 96 mm; vis fileté M10

00324683000 00-324683-000 324683

**376181**

**Service KIT**  
mod. AMX70/AUX70/FTN-SB/UX30/UX60

00-324815-004 00-324815-104 00895444000  
00-895444-000 324815104 324815-104  
3248154 324815-4 895444  
ML74328

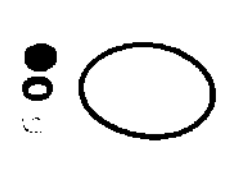
**405818**

**Service KIT**

00897225001 00-897225-001 8972251  
897225-1 ML102874

**322741**

**Turbine Ø 51,5 mm, Øext. 72 mm**  
moyeu M6

00774986104 00-774986-104 774986104  
774986-104

**322736**

**Turbine Ø 60 mm**  
moyeu Ø 8x7 mm

00774986002 00-774986-002 7749862  
774986-2

**318421**

**Turbine Ø 72 mm**

00774986101 00-774986-101 774986101  
774986-101

**392672**

**Turbine Ø 106,5 mm H=54 mm**

01245088003 01-245088-003 012450883  
01-245088-3

**390941**

**Turbine Ø 120 mm 2,2kW 50Hz**

00229137001 00-229137-001 2291371  
229137-1

## Pompes

376194



Joint couvercle de pompe

00229402000

00-229402-000

229402

395024

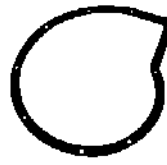

Pumpe joint

01245459001

01-245459-001

012454591

400600



Joint torique Ø 4,00x305 mm

00276903027  
276903-27

00-276903-027

27690327

395277

Joint couvercle de pompe  
dim. 310x270x2 mm01245386001  
01-245386-1

01-245386-001

012453861

400619

Impulseur et manchon  
dim: 80x75 mm; axe Ø 19 mm0027422700008  
274227-8

00-274227-00008

2742278

393247

Impulseur et manchon Ø 74 mm  
axe Ø 19 mm0027422700011  
00-274227-011

00-274227-00011

00274227011

408025



Disque Ø 108x156x1 mm

00781123001  
781123-1

00-781123-001

7811231

395280



Bride pour pompe Ø 47x127 mm

01245379001  
01-245379-1

01-245379-001

012453791

## Résistances

390868



Résistance cuve 200V 3000W

00229189013  
229189-13

00-229189-013

22918913

376322

Résistance cuve 1220W 254V  
dim. 420x64x50 mm; bride 81x28 mm; raccord M400229189026  
229189-26

00-229189-026

22918926

## Résistances

**376325****Résistance cuve 1830W 254V**

dim. 420x64x50 mm; bride 81x28 mm; raccord M4

00-229189-008  
229189008  
229189-2200229189022  
229189-008  
229189800-229189-022  
22918922  
229189-8**376331****Résistance cuve 2440W 254V**

dim. 420x64x42 mm; bride 81x28 mm; raccord M4

00-229189-004  
22918923  
229189-400229189023  
229189-2300-229189-023  
2291894**390852****Résistance cuve 3050W 254V**

dim. 420x64x42 mm; bride 81x28 mm; raccord M4

00229189024  
229189-24

00-229189-024

22918924

**390851****Résistance cuve 3660W 254V**

dim. 420x64x50 mm; bride 81x28 mm; raccord M4

00-229189-001  
00-229189-025  
2291892  
229189-2500-229189-002  
2291891  
229189-200229189025  
229189-1  
22918925**400216****Résistance cuve 4500W 254V**

L=625 mm; bride 81x28 mm; raccord M4

00325551001  
325551-1

00-325551-001

3255511

**408529****Résistance cuve 15000W 380V**

avec decoupé pourbulbe; raccord M5

00-435990-00006  
89281760089281700006  
892817-6

00-892817-00006

**322368****Résistance 7500W 220V**00229148011  
229148-11

00-229148-011

22914811

**390930****Résistance 9000W 230V**00229148062  
229148-62

00-229148-062

22914862

**318192****Resistance 9000W 230V**

L=510 mm; bride Ø 75 mm; raccord M4

00229148001  
229148-1

00-229148-001

2291481

**376361****Résistance 9000W 240V**

L=510 mm; bride Ø 74,5 mm; raccord M4

00229148002  
229148-2

00-229148-002

2291482

## Résistances

**390934****Résistance 9000W 254V**

00229148005      00-229148-005      2291485  
229148-5

**390935****Résistance cuve 12000W 230V**

L=610 mm; bride Ø 74,5 mm; raccord M4

00229148003      00-229148-003      00-229148-004  
2291483      229148-3      2291484  
229148-4

**390932****Résistance 12000W 254V**

00229148006      00-229148-006      2291486  
229148-6

**390931****Résistance 12000W**

00-229148-050      00229148060      00-229148-060  
22914850      229148-50      22914860  
229148-60

**387539****Joint 70x70x4 mm**

00229516000      00-229516-000      229516

**390368****Câble de connexion L=100 mm**

00227073095      00-227073-095      22707395  
227073-95

**397952****Bride avec joint 29x80,5 mm**

00774808001      00-774808-001      7748081  
774808-1

**391070****Plaque brûleur Ø 262 mm 36kW**

00229490003      00-229490-003      2294903  
229490-3

## Transformateurs

**390229****Transformateur 400W 50/60Hz**

dim. 112x126x107 mm; PRI- 400-415-440V - SEC- 220/230V

00226211015      00-226211-015      22621115  
226211-15

**397529****Transformateur 440-200/220-240 630 VA**

00695543001      00-695543-001      695543-001  
6955431      695543-1

## Câbles

382797



**Boîte de connexion [KIT]**  
dim. 90x90x35 mm

00-229513-002  
2295132

00896967000  
229513-2

00-896967-000  
896967

376298



**Passe-fils à vis M32 - câble Ø 21 mm**

00695661005  
695661-5

00-695661-005

6956615

385626



**Passe-fils Ø 12,5x20,5x7 mm**

00064824

00-064824

64824

376310



**Pass-fil Ø 29x41 mm**

00886756003  
886756-3

00-886756-003

8867563

## Thermostats

390350



**Thermostat à contact de sécurité**  
fileté M5; CH16

00227743003  
227743-3

00-227743-003

2277433

383428



**Thermostat d'utilisation 1P 85°C**  
capillaire revêtu L=1150 mm; bulbe Ø 4x200 mm; axe Ø 6x3,3 mm; faston 6,3x0,8 mm

00-226505-004  
226505004  
897927

00897927000  
2265054

00-897927-000  
226505-4

400373



**Thermostat d'utilisation 1P 86÷266°F**  
capillaire L=1200 mm; bulbe Ø 13x130 mm;  
presse étoupe M17

002946810312  
294681-31-2

00-294681-031-2

294681312

376447



**Thermostat de sécurité 3P 100°C 20A**  
capillaire revêtu L=870 mm; bulbe Ø 4x230 mm

00378791000

00-378791-000

378791

## Rideaux

**322815**

**Rideau double 575xh300 mm**  
sans axe

01291315002    01-291315-002    012913152  
01-291315-2

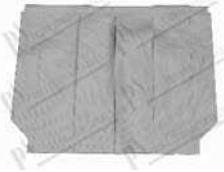
**322807**

**Rideau double 600xh475 mm**  
sans axe

01291315001    01-291315-001    012913151  
01-291315-1

**395179**

**Rideau double 615xh370 mm**  
sans axe

01245398002    01-245398-002    012453982  
01-245398-2

**317414**

**Rideau double 618xh530 mm**  
sans axe

01245398005    01-245398-005    012453985  
01-245398-5

**376433**

**Rideau double 630xh300 mm**  
sans axe

00781284001    00-781284-001    7812841  
781284-1

**376430**

**Rideau double 630xh430mm**  
sans axe

00230781000    00-230781-000    230781

**407849**

**Rideau double 630xh495 mm serie CN**  
sans axe

00781067002    00-781067-002    7810672  
781067-2

**376432**

**Rideau double 635xh390mm**  
sans axe

00231602001    00-231602-001    2316021  
231602-1

**376434**

**Rideau double 660xh420 mm**  
sans axe

00781033001    00-781033-001    7810331  
781033-1

**376435**

**Rideau double 630xh425mm**  
sans axe

00781067001    00-781067-001    7810671  
781067-1



## Rideaux

**322812**

**Rideau double 645x430 mm**  
sans axe

01291315003 01-291315-003 012913153  
01-291315-3

**376437**

**Rideau double 740x410/365 mm**  
sans axe

00229436001 00-229436-001 2294361  
229436-1

**395185**

**Rideau double 745x300 mm**  
sans axe

01245398003 01-245398-003 012453983  
01-245398-3

**395194**

**Rideau double 750x385/360 mm**  
sans axe

01245398001 01-245398-001 012453981  
01-245398-1

**376441**

**Rideau double 750x480 mm**  
sans axe

00325346005 00-325346-005 3253465  
325346-5

**317411**

**Rideau double 750x540/520 mm**  
sans axe

01245398004 01-245398-004 012453984  
01-245398-4

**395225**

**Rideau double 760x345 mm**  
sans axe

01245398008 01-245398-008 012453988  
01-245398-8

**395226**

**Rideau double 895x360 mm**  
sans axe

01245398007 01-245398-007 012453987  
01-245398-7

**395193**

**Rideau double 897x520/545 mm**  
sans axe

01245398010 01-245398-010 0124539810  
01-245398-10

**395269**

**Crochet de rideau**  
L=97 mm

01245395001 01-245395-001 012453951  
01-245395-1

## Rideaux

## Axe de rideau



<b>376032</b>	Ø 7 mm	L=600 mm	<b>229326-1</b>	<b>376028</b>	Ø 8 mm	L=680 mm	<b>231540-2</b>
<b>398024</b>	Ø 8 mm	L=600 mm	<b>774644-1</b>	<b>408609</b>	Ø 9,5 mm	L=600 mm	<b>887701-1</b>
<b>395266</b>	Ø 8 mm	L=645 mm	<b>01-245396-6</b>	<b>583012</b>	Ø 10 mm	L=750 mm	<b>01-245396-1</b>
<b>395265</b>	Ø 8 mm	L=657 mm	<b>01-245396-7</b>	<b>395268</b>	Ø 10 mm	L=898 mm	<b>01245396-3</b>

## Groupe de lavage

## 397845



**Rampe de lavage**  
dim. 59/75x116x395 mm

00774502001 00-774502-001 7745021  
774502-1

## 394178



**Wash arm Ø 25x565 mm**  
4 injecteur - CS, CN, CP

01291340001 01-291340-001 012913401  
01-291340-1

## 395152



**Bras de lavage Ø 25x660 mm**  
7 trou Ø 5x4,5 mm - FTN/FTP

01245262001 01-245262-001 012452621  
01-245262-1

## 410416



**Bras de lavage 25x715 mm**  
7 injecteur - FTN

00885527001 00-885527-001 8855271  
885527-1

## 395151



**Bras de lavage Ø 25x800 mm**  
FTN/FTP

01245262002 01-245262-002 012452622  
01-245262-2

## 394933



**Bras de lavage superieure Ltot.=780 mm**  
FTN/FTP

01245492009 01-245492-009 012454929  
01-245492-9

## Groupe de lavage

**394887**

**Bras de lavage supérieure Ltot.=780 mm**  
FTN/FTP

01245492010      01-245492-010      0124549210  
01-245492-10

**394886**

**Bras de lavage inférieur Ltot.=780 mm**  
FTN/FTP

01245492011      01-245492-011      0124549211  
01-245492-11

**394885**

**Bras de lavage inférieur Ltot.=780 mm**  
FTN/FTP

01245492012      01-245492-012      0124549212  
01-245492-12

**394884**

**Bras de lavage inférieur Ltot.=780 mm**  
FTN/FTP

01245492013      01-245492-013      0124549213  
01-245492-13

**394883**

**Bras de lavage inférieur Ltot.=780 mm**  
FTN/FTP

01245492014      01-245492-014      0124549214  
01-245492-14

**391064**

**Bras de rinçage Ø 16x645 mm - L=665 mm**  
FTX, CX

00229511002      00-229511-002      2295112  
229511-2

**402778**

**Bras de rinçage Ø 22x920 mm**  
Ltot. 952 mm; fletée 3/4" - FTX

00374729002      00-374729-002      3747292  
374729-2

**388117**

**Bras de rinçage Ø 22x1140 mm**  
FTX, CX

00229883000      00-229883-000      229883

**410421**

**Bras de rinçage Ø 25x605 mm**  
CSA

00885503003      00-885503-003      8855033  
885503-3

**395156**

**Bras de rinçage Ø 25x660 mm**  
7 troue - ECOMAX 900, FTN/FTP

01245258001      01-245258-001      012452581  
01-245258-1

## Groupe de lavage

**394201**

**Bras de rinçage Ø 25x570 mm**  
CS, CN, CP

01291305001 01-291305-001 012913051  
01-291305-1

**407957**

**Bras de rinçage L=580 mm**  
CN, CR, CNR

00781210001 00-781210-001 7812101  
781210-1

**409977**

**Bras de rinçage Ø 25x610 mm**  
4 injecteurs - ECOMAX 800, CSA

00885527005 00-885527-005 8855275  
885527-5

**395166**

**Bras de rinçage Ø 25x650 mm**  
7 injecteur - ECOMAX 900, FTN/FTP

01-245255-001 012452551 01-245255-1  
01245255-1

**395155**

**Bras de rinçage supérieur Ø 25x800 mm**  
5 injecteurs - FTN/FTP

01245254002 01-245254-002 012452542  
01-245254-2

**409960**

**Support bras de rinçage**  
H=37 mm; CH50 mm

00885572001 00-885572-001 8855721  
885572-1

**407851**

**Tuyau de branchement jets**  
dim. 740x1180x165 mm

00781055001 00-781055-001 7810551  
781055-1

**392757**

**Tuyau de branchement jets**

01242149001 01-242149-001 012421491  
01-242149-1

**395104**

**Tuyau de branchement jets**  
Ø 25x520 mm

01245323003 01-245323-003 012453233  
01-245323-3

**395450**

**Tuyau Ø 24x25/27x56 mm**

01291297001 01-291297-001 012912971  
01-291297-1

## Groupe de lavage

383831



**Bouchon 3/4"**  
Ø 32 mm, 14x14 mm

00603412000

00-603412-000

603412

376413



**Bouchon pour bras de lavage**

01245084001  
01-245084-1

01-245084-001

012450841

392678



**Bouchon Ø 60 mm**

01245084002  
01-245084-2

01-245084-002

012450842

319656



**Bouchon Ø 42x52,5 mm**

00106769000

00-106769-000

106769

392680



**Bouchon jet de rinçage Ø 23,5x28xH28 mm**

01245080001  
01-245080-1

01-245080-001

012450801

400124



**Bouchon bras de rinçage Ø 21,5 mm**

00325316001  
325316-1

00-325316-001

3253161

392681



**Bouchon bras de rinçage Ø 24,5 mm**

01245080002

01-245080-002

387361



**Bouchon Ltot=27 mm**

00229330000

00-229330-000

229330

322755



**Injecteur bras de rinçage**

00885520006  
885520-6

00-885520-006

8855206

397991



**Injecteur**  
Ø 28/38xHtot.=29 mm

00774722001  
774722-1

00-774722-001

7747221

## Groupe de lavage

**397988**

**Raccord 90°**  
dim. 101x75,5x104 mm

00774618001 00-774618-001 7746181  
774618-1

**395066**

**Raccord 90°**  
Ø 23.5x15 mm; M42

01245318002 01-245318-002 012453182  
01-245318-2

**395095**

**Raccord en T Ø 20-20 mm - L=80 mm**  
Øint. 15-15 mm

01245318001 01-245318-001 012453181  
01-245318-1

**407555**

**Tuyau intermédiaire Ø 66x73/95x195 mm**

00870442001 00-870442-001 8704421  
870442-1

**398474**

**Agrafe de tuyau Ø 26xh10 mm**

00775512001 00-775512-001 7755121  
775512-1

**409970**

**Bague Ø 24x27/38x14,5 mm**

00885538001 00-885538-001 8855381  
885538-1

**400125**

**Bague bras de rinçage Ø 22 mm**  
Øint. 12 mm

00325308001 00-325308-001 3253081  
325308-1

**399562**

**Bague bras de lavage L=36 mm**

00325112004 00-325112-004 3251124  
325112-4

**409972**

**Ecrou support bras de lavage Ø 62 mm**  
H=32 mm; CH50 mm

00885536001 00-885536-001 8855361  
885536-1

**397946**

**Ecrou Ø 29 mm**  
H=16 mm; CH50

00774723001 00-774723-001 7747231  
774723-1

## Groupe de lavage

**376102**

**Ecrou Ø 34,5x7,5 mm**  
CH 30 mm

00324384000

00-324384-000

324384

**404211**

**Ecrou support bras de rinçage**

00896971001  
896971-1

00-896971-001

8969711

**397945**

**Ecrou Øext. 62 mm**  
H=13 mm; CH50

00774724001  
774724-1

00-774724-001

7747241

**317536**

**Anneau Ø 48x23 mm**

00229568002  
229568-2

00-229568-002

2295682

**397309**

**Rondelle Ø 68x95x0,8 mm**

00696936044  
696936-44

00-696936-044

69693644

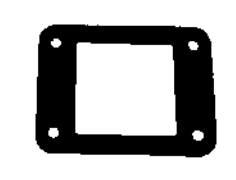
**319339**

**Joint 100x78x2 mm**

00296709000  
01242580100-296709-000  
01-242580-101-242580-001  
296709**376190**

**Joint plane Ø 12x18x2 mm**

00229323000

00-229323-000

229323

**390414**

**Joint plane Ø 26x42x3 mm**

00172986027  
172986-27

00-172986-027

17298627

**376188**

**Joint plane Ø 43x58x3 mm**

00172986026  
172986-26

00-172986-026

17298626

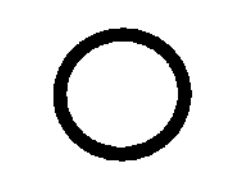
**395083**

**Joint plane Ø 56x64x1,4 mm**

01245460001  
01-245460-1

01-245460-001

012454601

## Groupe de lavage

**376412****Joint pour bras de lavage**

00885500001 00-885500-001 8855001  
885500-1

**394217****Support brace de lavage inférieur**  
dim. 95x65x70 mm

01291341001 01-291341-001 012913411  
01-291341-1

**394179****Support brace de lavage supérieur**  
dim: 80x30x65 mm

01291337001 01-291337-001 012913371  
01-291337-1

**400039****Disque Ø 38x2,5 mm**

00326011001 00-326011-001 3260111  
326011-1

**392677****Bouchon 45,6x67,5 mm**

01245086001 01-245086-001 012450861  
01-245086-1

**395089****Guide de bras de lavage supérieur gauche**  
dim. 757xh108 mm

01-245332-002 012453322

**395084****Guide de bras de lavage supérieur droit**  
dim. 757xh108 mm

01-245333-001 012453331

## Vanne de vidange

**376115****Vanne de vidange 180° - 1 voie - 20W**  
220/230V 50Hz  
entrée/sortie sortie 40 mm; L=140 mm - eau chaude

00774683001 00-774683-001 774683-01  
7746831 774683-1

**378609****Vanne de vidange 180° - 1 voie - 15,4/20W**  
220-230V 50/60Hz  
entrée Ø 17 mm, sortie Ø 19 mm; 0,5 bar, DN10 - eau chaude

00323592001 00-323592-001 3235921  
323592-1



## Vanne de vidange

**404236**

**Bobine pour vanne de vidange 20W 230V  
50Hz**  
15,4W 230V 60Hz

00897215001  
897215-1

00-897215-001

8972151

**376495**

**Soupape 90° - 1 voie - avec flotteur - Ø 14  
mm**

00897665001  
897665-1

00-897665-001

8976651

**406573**

**Joint vanne de vidange [Kit]**  
Joint torique 2,62x45,69 mm; joint Ø 29 mm

ML75068

## Chambres air

**405796**

**Écrou chambre de compression**  
joint Ø 26x42x3 mm

00774670001  
774670-1

00-774670-001  
ML102830

7746701

**376500**

**Chambre de compression**  
embout tuyau Ø 13 mm; mod. ECOMAX 602-1C  
sans adoucisseur

00775759001  
775759-1

00-775759-001

7757591

**399439**

**Chambre de compression 55x78x17 mm  
[KIT]**  
embout tuyau Ø 5 mm

00324858001  
324858-1

00-324858-001

3248581

## Serpentin

**318197**

**Echangeur thermique à vapeur**  
dim. 600x210x140 mm

00229742000

00-229742-000

229742

**394877**

**Condensator 550x490x190 mm**

01245490007  
01-245490-7

01-245490-007

012454907

## Electrovannes et Réducteurs

**318194**

**Electrovalve 180° - 1 voie - 24V 50/60Hz - Ø 3/4"**  
entrée/sortie Ø 3/4"; Tu 60°C - Tm 90°C

00734242004  
734242-4

00-734242-004

7342424

**378642**

**Electrovalve 180° - 1 voie - 220/240V 50/60Hz - Ø 3/4"**  
entrée/sortie Ø 3/4"; sortie Øint. 13 mm; Tu 60°C - Tm 90°C

00734242003  
734242-3

00-734242-003

7342423

**400485**

**Electrovalve 180° - 1 voie - 220/240V 50/60Hz - Ø 3/4"**  
entrée/sortie Ø 3/4" avec filtre; sortie Øint. 10 mm; Tmax. 90°C

00297808001  
00493351001  
297808-1  
493351100-297808-001  
00-493351-001  
3234831  
493351-100-323483-001  
2978081  
323483-1**400484**

**Electrovalve 180° - 1 voie - 220/240V 50/60Hz - Ø 3/4"**  
entrée/sortie Ø 3/4" avec entrée réducteur orange

00297808011  
297808-11

00-297808-011

29780811

**378643**

**Electrovalve 180° - 1 voie - 220/240V 50/60Hz - Ø 3/4"**  
entrée/sortie Ø 3/4" avec filtre et réducteur entrée 8L/min (noir); sortie Ø 10 mm; Tmax. 90°C

00297808010  
297808-10

00-297808-010

29780810

**376112**

**Electrovalve 180° - 1 voie - 220/240V 50/60Hz - Ø 3/4"**  
entrée/sortie Ø 3/4" avec réducteur entrée 20L/min (vert); sortie Ø 10 mm; Tmax. 90°C

00297808012  
297808-12

00-297808-012

29780812

**400480**

**Electrovalve 180° - 1 voie - 220/240V 50/60Hz - Ø 3/4"**  
entrée/sortie Ø 3/4" avec filtre et réducteur entrée blanc; sortie Ø 10 mm; Tmax. 90°C

00297808007  
297808-7

00-297808-007

2978087

**390777**

**Electrovalve en laiton 3/8" FF 9W 110/120V 50/60Hz**  
corps L=64,3 mm

0027100600001  
271006-1

00-271006-00001

2710061

**390738**

**Electrovalve en laiton G3/4" 110/120V 50/60Hz**  
bobine 9W 110/120V 50/60Hz

0027100200001  
271002-1

00-271002-00001

2710021

**391007**

**Electrovalve en laiton NC - G1/2" - 220-240V 50/60Hz**  
L=70 mm; bobine 220/230V 50Hz

00229677001  
229677-1

00-229677-001

2296771

## Electrovannes et Réducteurs

388975



**Electrovanne en laiton G1/2" 220/240V 50/60Hz**

L=95 mm; bobine 220/240V 50/60Hz 9,6W; membrane in PFTE; Psteam 2-50 PSI

0011209100002  
112091-2

00-112091-00002

1120912

397984



**Electrovanne en laiton G1/2" 230V 50/60Hz**

L=70 mm; bobine 230V 50/60Hz; Pmax 10bar

00-228894-001  
2288941  
774624-1

00774624001  
228894-1

00-774624-001  
7746241

390751



**Electrovanne en laiton G3/4" 208/240V 60Hz**

bobine 10,5W 208/240V 60Hz

0027032900002  
270329-2

00-270329-00002

2703292

582098



**Service KIT**

pour electrovanne 388974 en 388975

00-114299

114299

## Vannes sphériques, Raccords

381444



**Mamelon Ø 3/4"÷1/2" - L=36 mm - laiton**

00602757000

00-602757-000

602757

387404



**Mamelon 3/4" - 3/4" - L=36 mm - laiton**

00227931000

00-227931-000

227931

582962



**Mamelon Ø 3/4"÷3/4" - L=55 mm - en laiton CH36**

01245850001  
01-245850-1

01-245850-001

012458501

401009



**Raccord cannelé 90° - G1/2"**

00299240001  
299240-1

00-299240-001

2992401

404044



**Raccord cannelé 90° pour tuyau Ø 13 mm ecrou 3/4"**

00897694002  
897694-2

00-897694-002

8976942

394838



**Raccord cannelé 90°**

00-897694-001  
012455601  
897694-1

01245560001  
01-245560-1

01-245560-001  
8976941

## Vannes sphériques, Raccords

**394716****Raccord cannelé 90° pour tuyau Ø 15 mm**01296696001  
01-296696-1

01-296696-001

012966961

**395110****Raccord cannelé G1/2" - sortie Ø 10 mm**01245329001  
01-245329-1

01-245329-001

012453291

**390362****Raccord cannelé G1/8" - sortie Ø 5,50 mm**00227249001  
2272491  
227249-300-227249-001  
227249-100-227249-003  
2272493**404337****Raccord cannelé G3/4" - sortie Ø 12 mm  
L=44 mm**00897680001  
897680-1

00-897680-001

8976801

**395016****Raccord en T Ø 13-13 mm**01245654001  
01-245654-1

01-245654-001

012456541

**404042****Raccord avec raccord cannelé Ø 13 mm  
Ltot=109 mm  
fileté 3/4"**00897699001  
897699-1

00-897699-001

8976991

**390711****Raccord 90° Ø 40 mm  
dim. 95x95 mm**00230080002  
230080-2

00-230080-002

2300802

**390712****Raccord 90° Ø 46x50 mm  
avec joint**00230080001  
230080-1

00-230080-001

2300801

**383877****Raccord en T Ø 3/4" F - L=59x45,5 mm  
DVGW**

00603163000

00-603163-000

603163

**395419****Raccord en T Ø 3/4" - 1/2" - 3/4" - L=50x45 mm**01291288001  
01-291288-1

01-291288-001

012912881

## Vannes sphériques, Raccords

**399633**

T-raccord T Ø 50M-50F-40F mm  
dim. 152xh115 mm

00323593002  
323593-2

00-323593-002

3235932

**390713**

Raccord en T Ø 50x50x50 mm  
dim. 160x105 mm; avec joint

00230079001  
230079-1

00-230079-001

2300791

**390601**

Raccord en Y Ø 13-13-13 mm

00174047001  
174047-1

00-174047-001

1740471

**381642**

Raccord 3/4" L=36 mm

00602403000

00-602403-000

602403

**381659**

Collier 1"

00600806000  
600806

00-600806-000  
602409

00-602409-000

**390992**

Tuyau de connexion Øint. 50x105 mm

00229680001  
229680-1

00-229680-001

2296801

**392785**

Robinet chargement eau 3/4"  
PN100

01241853002  
01-241853-2

01-241853-002

012418532

**386900**

Valve anti-réflux L=123 mm

00324091000

00-324091-000

324091

**400346**

Valve anti-réflux 1/2" FF 180°F/125PSI

0029290900002  
292909-2

00-292909-00002

2929092

**404361**

Valve anti-réflux 3/4" - L=64 mm  
DN20, PN16

00897668001  
897668-1

00-897668-001

8976681

## Tuyaux

407686



Tuyau formé Ø 30x38x84 mm

00781335001  
781335-1

00-781335-001

7813351

382800



Tuyau formé [Kit]

raccords 45° Ø 30x38x84 mm; raccords 90° Ø 30x38 mm dim. 100x100 mm; agrafe de tuyau Ø 35-40 mm

00-781336-001  
781336100896964000  
781336-100-896964-000  
896964

396823



Manchon Ø 49x67 mm L=90 mm

00693255003  
693255-3

00-693255-003

6932553

395491



Tuyau pour raccord 3/4"MF - L=275 mm

01291004003  
01-291004-3

01-291004-003

012910043

582855



Tuyau formé 90°

01245307001  
01245307101-245307001  
01-245307-1

01-245307-001

387505

Tuyau d'aspiration Ø 110 mm  
dim. 155x175 mm

00229434000

00-229434-000

229434

387128

Tuyau formé  
dim. 180x130x30 mm; M24; CH 30

00300707000

00-300707-000

300707

200005



Tuyau en EPDM Ø 5x12 mm (vendu au mètre)

E143005

402829



Tuyau en EPDM Ø 5x12 mm L=1000 mm

00-139321-127  
139321127  
371450-17300371450173  
139321-12700-371450-173  
371450173

200002

Tuyau en EPDM Ø 12x19,5 mm (vendu au mètre)  
pour eau chaude - Pmax 10 bar - temp. de travail -35°C+120°C

E143010

## Tuyaux

**394824**

Tuyau en EPDM Ø 13x20 mm L=1000 mm  
Pmax 90 bar

01245571001  
01-245571-1

01-245571-001

012455711

**394832**

Tuyau en EPDM Ø 13x20 mm L=3000 mm  
90 bar

01245571003  
01-245571-3

01-245571-003

012455713

**394861**

Tuyau EPDM Ø 13x20x2000 mm

01-245571-00002  
012455712

01245571002  
01-245571-2

01-245571-002

## Composants de vidange

**387509**

Collecteur de vidange Ø 50x140 mm

00229419000

00-229419-000

229419

**392700**

Collecteur de vidange

01245109001  
01-245109-1

01-245109-001

012451091

**376084**

Collecteur de vidange Ø 75x105x110 mm  
tuayu Ø 31 mm

00323802001  
323802-1

00-323802-001

3238021

**376158**

Bride avec joint Ø 70x107 mm

00-324053-000  
324053

00886639000  
886639

00-886639-000

**376174**

Joint Ø 80x100xH3,85 mm

00324056000

00-324056-000

324056

**390149**

Bonde de vidange Ø 1" 1/2 H=20 mm  
Øint. 41 mm

00226558001  
226558-1

00-226558-001

2265581

## Composants de vidange

**392683**

Bonde de vidange Øint. 45 mm - H=55,5 mm

01245112001  
01-245112-1

01-245112-001

012451121

**399719**

Tuyau de trop-plein avec filtre Ø 155 mm  
Ltot.=460 mm; tuyau Øint.36/est.28 mm

00323534002  
3235342  
774412-2

00-323534-002  
323534-2

00-774412-002  
7744122

**381535**

Tuyau de trop-plein Ø 50x550 mm

00600571000

00-600571-000

600571

**389175**

Tuyau de trop-plein Ø 51x370 mm

0011909900002  
119099-2

00-119099-00002

1190992

**317525**

Tuyau de trop-plein Ø 52x360 mm

2294271  
229427-1V

229427-1

2294271V

**317534**

Tuyau de trop-plein Ø 52x360 mm

00230346002  
230346-2

00-230346-002

2303462

**385362**

Tuyau de trop-plein Ø 64/16x340mm

00153085000

00-153085-000

153085

## Filtres

**397806**

Filtre à eau 3/4"  
en plastique L=120 mm

00774810001  
774810-1

00-774810-001

7748101

**392701**

Filtre Ø 99,50 mm - H=2 mm

01245107001  
01-245107-1

01-245107-001

012451071



**Filtres**

**398232**



Filtre Ø 106 mm

00775750001      00-775750-001      7757501  
775750-1

**395284**



Filtre 85x74 mm

01245377001      01-245377-001      012453771  
01-245377-1

**395283**



Filtre 85x120 mm

01245377002      01-245377-002      012453772  
01-245377-2

**394975**



Filtre à panier 90x270x115 mm

01245867001      01-245867-001      012458671  
01-245867-1

**382083**



Filtre à panier 516/410x68x185 mm

00375221000      00-375221-000      375221

**378627**



Filtre à panier 330x120x115 mm  
mod. CS/CN/CP

01245170010      01-245170-010      0124517010  
01-245170-10

**394315**



Filtre à panier

01291515002      01-291515-002      012915152  
01-291515-2

## Eléments de transmission

**387795****Maillon d'accouplement 3/4"**

00226485000

00-226485-000

226485

**401540****Maillon d'accouplement 3/4"**00-377016-000  
37701600377016001  
377016100-377016-001  
377016-1**391750****Chaîne 3/4" - 74 maillons**00168703010  
168703-10

00-168703-010

16870310

**398559****Chaîne 3/4" - 81 maillons L=1050 mm**00732448002  
732448-2

00-732448-002

7324482

**392825****Poulie Ø 151 mm H=23,45 mm**  
carrière 15 mm; avec palier Ø 20x42x12 mm00-374962-017  
012419102  
374962-1701241910002  
01-241910-201-241910-002  
37496217**392826****Poulie Ø 20x150x23 mm**00-896275-001  
012419101  
896275-101241910001  
01-241910-101-241910-001  
8962751**407804****Poulie Ø 60 mm**  
filetée M1000781814001  
015186911  
781814-100-781814-001  
01-518691-101-518691-001  
7818141**399610****Roue dentée - 9 dentée**  
trou pour axe Ø 30 mm00325034001  
325034-1

00-325034-001

3250341

**399608****Roue dentée Ø 205 mm - 32 dentée**  
trou pour axe Ø 30 mm00325036001  
325036-1

00-325036-001

3250361

## Composant structuraux

**320403****Cadre**

00868283001 00-868283-001 8682831  
868283-1

**396851****Rouleau Ø 50x500 mm**  
axe Ø 10 mm

0014969800001 00-149698-00001 00693217001  
00-693217-001 1496981 149698-1  
6932171 693217-1

**322621****Panneau de couverture 1035x780x70 mm**  
dim. 1035x780x70 mm

01245475002 01-245475-002 012454752  
01-245475-2

**380928****Protection 500x270x1 mm**

00494213000 00-494213-000 494213

**392689****Support 128x100x30 mm**

01245127001 01-245127-001 012451271  
01-245127-1

**402716****Levier de vidange L=110 mm**

00375215001 00-375215-001 3752151  
375215-1

## Doigt transporteur

**397998****Doigt transporteur L=100 mm h=90 mm**

00774568001 00-774568-001 7745681  
774568-1

**397992****Doigt transporteur 122x38x90,5 mm**  
distance de trous 109 mm

00774613001 00-774613-001 7746131  
774613-1

**387347****Doigt transporteur 70x19x87 mm**  
distance de trous 58,5 mm

00229102000 00-229102-000 229102

**407803****Doigt transporteur 38x75x99 mm**

00781906001 00-781906-001 7819061  
781906-1

**Doigt transporteur**

**382802**



**Doigt transporteur (10 pcs)**

00-325477 -001    00-325477-001    00896958000  
 00-896958-000    3254771    325477-1  
 896958

**390910**



**Espaceur**  
 distance de trous 58,5 mm

00229049002    00-229049-002    2290492  
 229049-2

**392738**



**Levier autotimer G/D**

01242189001    01-242189-001    012421891  
 01-242189-1

**407892**



**Autotimer D/G**

00781088002    00-781088-002    7810882  
 781088-2

**400191**



**Bague Ø 30x120x26,5 mm**

00325243001    00-325243-001    3252431  
 325243-1

**376369**



**Rouleau Ø 7,4x20/25x24,5 mm**

00229319000    00-229319-000    229319

**376368**



**Rouleau Ø 8,3x20/26 mm L=26 mm**

00774643001    00-774643-001    7746431  
 774643-1

**384517**



**Rouleau Ø 10x20,5/25,5x30 mm**

00749952    00-749952    749952

**402745**



**Roller**

00-375870-000    00375870001    00-375870-001  
 375870    3758701    375870-1

**401303**



**Bague Ø 6x12x25 mm**

00380528037    00-380528-037    38052837  
 380528-37

## Doigt transporteur

392905



Bague Ø 8,5x11/14x16 mm

01243284001  
01-243284-1

01-243284-001

012432841

394216



Catch

dim: 90x40x3 mm

01291371001  
01-291371-1

01-291371-001

012913711

382808



Levier cna/cnr [KIT]

bague Øint. 8,5/est. 11/14 H=16 mm; vis TE M8x35 mm

00-493439-000  
00-781162-001  
00-895416-000  
7811611  
7811621  
781163-100-493440-000  
00-781163-001  
493439  
781161-1  
781162-1  
89541600-781161-001  
00895416000  
493440  
781162-001  
7811631

402085



Came L=95 mm

FRONT R to L - REAR L to R

0043670400001  
436704-1

00-436704-00001

4367041

402125



Came L=95 mm

FRONT L to R - REAR R to L

0043670400002  
436704-2

00-436704-00002

4367042

395706

Cordon pour tapis convoyeur Ø 15 mm  
L=10mt - bleu01247463001  
01-247463-1

01-247463-001

012474631

## Thermomètres

402133



Thermometre Ø 52 mm 40÷105°C

bulbe Ø 11x66 mm; capillaire L=2450 mm;  
presse étoupe Ø 15,5 mm CH16 mm00-276923-00006  
2769236  
437041-30043704100003  
276923-600-437041-00003  
4370413

390292



Thermometre 30÷120°C

bulbe Ø 8,6x35 mm; capillaire L=3000 mm; dim  
24,70x57,70 mm00-228720-002  
2287202  
228720-300228720003  
228720-200-228720-003  
2287203

## Manomètres, Vannes de sécurité

**376230**

Manomètre 0-1 bar Ø 63 mm; raccord.  
inf. Ø 1/4" BSP

00229583001  
229583-1

00-229583-001

2295831

## Composants mécaniques

**402708**

Circlip Ø 18,5/20x1,2

00372955001  
372955-1

00-372955-001  
QA01146

3729551  
QA011-46

**402815**

Circlip Ø 35x1,5 mm

00374960001  
374960-1

00-374960-001

3749601

**405311**

Circlip Øest 12,8x0,7 mm INOX

RR00623  
RR-6-23

RR-006-23

RR623

**399647**

Amortisseur Ø 14xhtot.7 mm

00323785101  
323785-101

00-323785-101

323785101

**320409**

Bague

00154795000

00-154795-000

154795

**320408**

Bague

00154789000

00-154789-000

154789

**392904**

Bague Ø 11x16x15 mm

01243284002  
01-243284-2

01-243284-002

012432842

**387462**

Bride bague Ø 8,5x12,8/16x8 mm

00229566000

00-229566-000

229566

## Composants mécaniques

**392068****Bague Ø 20,80x40/50x22 mm**01241005001 01-241005-001 012410051  
01-241005-1**381652****Clavette 4x4x16 mm**

00602344000 00-602344-000 602344

**381567****Clavette 6x6x20 mm**

00600683000 00-600683-000 600683

**439006****Clavette 6x6x25 mm - INOX**00298687002 00-298687-002 2986872  
298687-2**381469****Goupille fendue Ø 2x20 mm**00602884000 00-602884-000 00-603460-000  
602884 603460**376083****Goupille fendue Ø 2,7x18mm**

00602886000 00-602886-000 602886

**383931****Goupille fendue 2,8x16 mm**  
Ltot.=25 mm

00603274000 00-603274-000 603274

**438438****Ecrou hexagonal M6 autofreisés - INOX**

00602502000 00-602502-000 602502

**322630****Ecrou hexagona M8x8 INOX**  
indesserrable0016340900002 00-163409-00002 00-602503-000  
1634092 163409-2 602503**381319****Ecrou hexagonal M12 autofreisés**

00602505000 00-602505-000 602505

## Composants mécaniques

**582965****Ecrou hexagona M8 - INOX**

00-602492-000

602492

602492000

**381629****Ecrou hexagona 1/4" - H=6,60 mm**

00602476000

00-602476-000

602476

**390391****Ecrou hexagonal 1/2" - H=5,5 mm  
CH28**00172739009  
172739-9

00-172739-009

1727399

**390396****Ecrou hexagonal 3/4" - H=4,5 mm  
CH30 mm**00172739002  
172739-2

00-172739-002

1727392

**418034****Ecrou hexagonal borgne M6  
H=11,5 mm**

00603036000

00-603036-000

603036

**399592****Entretoise Ø 22,5x25x6,2 mm**00324902001  
324902-1

00-324902-001

3249021

**398027****Entretoise L=39 mm**00774641001  
774641-1

00-774641-001

7746411

**399441****Collier de serrage Øint. 310/20 mm**00324848001  
324848-1

00-324848-001

3248481

**399411****Collier de serrage Øint. 98/20 mm**00324735002  
324735-2

00-324735-002

3247352

**409464****Bouchon Ø 35 mm**00883271001  
883271-1

00-883271-001

8832711



## Composants mécaniques

401518



Rouleau Ø 59,50 mm H=17,4 mm

00377373003  
377373-3

00-377373-003

3773733

387719

Bouchon 1/8"  
L=12 mm

00226989000

00-226989-000

226989

382085



Guide L=140 mm

00375213000

00-375213-000

375213

395654

Bouchon Ø 72 mm  
filée M10x18 mm00-229585-000  
01248160101248160001  
01-248160-101-248160-001  
229585

385249



Plaque de fixation 54,4x15,3 mm

00142413000

00-142413-000

142413

325216



Plaque 25x84x2 mm

00898598001  
898598-1

00-898598-001

8985981

397843



Plaque 105x38x21 mm

00774503001  
774503-1

00-774503-001

7745031

399557

Bride de fixation  
dim. 32x20xh17 mm00325164001  
325164-1

00-325164-001

3251641

432605

Rondelle plate M6 Ø 6,4x11,6x1,6 mm  
INOX00602286000  
60228600-602286-000  
603462

00-603462-000

320422



Rondelle plate Ø 8x24x2 mm

00781490001  
781490-1

00-781490-001

7814901

## Composants mécaniques

**322015**

Rondelle plate M10 INOX

00602288000

00-602288-000

602288

**390297**

Rondelle plate Ø 13x27x3 mm

00228694014  
228694-14

00-228694-014

22869414

**319332**

Rondelle plate Ø 12x16x2 mm

00696440001  
696440-1

00-696440-001

6964401

**381424**

Goupille fendue Ø 8,70x50 mm

00602849000  
60284900-602849-000  
603545

00-603545-000

**358118**

Vis tête hexagonale M6x16 - INOX

00-602570-000

602570

**373113**

Vis tête hexagonale M6x40 mm - INOX

00602643000

00-602643-000

602643

**381382**

Vis tête hexagonale M8x25 mm - INOX

00602976000  
00-699739-041  
699739-041  
SC411300-602976-000  
602976  
SC04113  
SC-41-1300699739041  
699739041  
SC-041-13**320421**

Vis tête hexagonale M8x55 mm

00602555000

00-602555-000

602555

**582729**

Vis à tête fendue M5x30 mm inox

SCME1236

SCM-E-12-36

**381681**

Vis M6x12 mm

00600699000  
60069900-600699-000  
602632

00-602632-000

## Composants mécaniques

## Collier de serrage avec vis



<b>376136</b>	Ø 17 mm		<b>323945-40</b>
<b>376140</b>	Ø 29 mm		<b>323945-29</b>
<b>376141</b>	Ø 34 mm		<b>323945-33</b>
<b>376143</b>	Ø 37 mm		<b>323945-37</b>
<b>376144</b>	Ø 53 mm		<b>323945-53</b>
<b>376145</b>	Ø 56 mm		<b>323945-56</b>
<b>376147</b>	Ø 64 mm		<b>323945-64</b>
<b>376135</b>	Bifilaire	Ø 15 mm	<b>323945-15</b>
<b>376137</b>	Bifilaire	Ø 18 mm	<b>323945-18</b>

<b>376138</b>	Bifilaire	Ø 21,50 mm	<b>323945-21</b>
<b>399773</b>	Bifilaire	Ø 23 mm	<b>323945-22</b>
<b>399659</b>	Bifilaire	Ø 23,50 mm	<b>323945-23</b>
<b>376139</b>	Bifilaire	Ø 25 mm	<b>323945-25</b>
<b>399829</b>	Bifilaire	Ø 35÷40 mm	<b>323945-40</b>
<b>376142</b>	Bifilaire	Ø 35 mm	<b>323945-35</b>
<b>399827</b>	Bifilaire	Ø 50 mm	<b>323945-49</b>
<b>399826</b>	Bifilaire	Ø 69 mm	<b>323945-68</b>
<b>399824</b>	Bifilaire	Ø 78 mm	<b>323945-76</b>

## Collier de serrage bifilaire



<b>399494</b>	Ø 6,3+7 mm		<b>324510-73</b>
<b>399494</b>	Ø 6,6+7 mm		<b>324510-81</b>
<b>399493</b>	Ø 7,3+7,8 mm		<b>324510-86</b>
<b>380343</b>	Ø 8,8+9,3 mm (5 pcs)		<b>324510-68</b>
<b>399518</b>	Ø 14,8+15,9 mm		<b>324510-173</b>
<b>376131</b>	Ø 17,7+18,7 mm		<b>324510-202</b>
<b>399501</b>	Ø 19,7+20,6 mm		<b>324510-192</b>
<b>376132</b>	Ø 21+23 mm		<b>324510-242</b>

<b>399497</b>	Ø 27,00+31,80 mm		<b>324510-313</b>
<b>399499</b>	Ø 22,00+23,70 mm		<b>324510-258</b>
<b>399498</b>	Ø 25,00+27,00 mm		<b>324510-287</b>
<b>376133</b>	Ø 27,60+29,20 mm		<b>324510-327</b>
<b>582968</b>	Ø 30,70+32,90 mm		<b>024510-356</b>
<b>399496</b>	Ø 33,20+34,80 mm		<b>324510-341</b>
<b>582967</b>	Ø 33,80+36,30 mm		<b>324510-388</b>
<b>582966</b>	Ø 35,20+39,20 mm		<b>324510-429</b>

## Coussinets

**404200**

Bearing

00897019001  
897019-1

00-897019-001

8970191

**383968**

Plaque tournante de roulement M8

00609067000

00-609067-000

609067

## Joint axe

**392526**

Joint d'étanchéité  
 Ø39,3x12x17mm/contre-joint  
 Ø45,4x21x7,5mm  
 Joint d'étanchéité

01-245033-001  
012450331  
01-245033-201245033002  
01-245033-101-245033-002  
012450332**320404**

Cadre de recouvrement

00868312001  
868312-1

00-868312-001

8683121

## Fermetures

**376229**

Aimant Ø 5x34x17 mm

00-325673-001  
3256731  
774714-100774714001  
325673-100-774714-001  
7747141**394740**

Aimant support 24,5x45/61x12,5 mm

01297033001  
01-297033-1

01-297033-001

012970331

## Surchauffeurs

**456092**

Surchauffeur 3 résistances  
 dim. Ø 250x460 mm

E927067

**404192**

Surchauffeur 5 résistances  
 dim. Ø 171x550 mm; raccord M21

00-897637-001  
8976371  
897683-100897683001  
897637-100-897683-001  
8976831

## Surchauffeurs

**376192**

Joint surchauffeur Ø 215x265x2 mm

00230994000

00-230994-000

230994

**381525**Bouchon 1/2" - H=12  
CH2300600588000  
60058800-600588-000  
602752

00-602752-000

**387547**Isolation de couverture  
Ø 292x70 mm; trou Ø 8 mm

00229491000

00-229491-000

229491

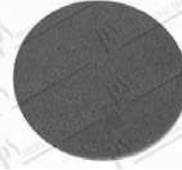
**404325**

Insulation Ø 165x10 mm

00897657002  
897657-2

00-897657-002

8976572

## Groupe de sûreté

**390954**

réducteur de pression 1/2"

00229110002  
229110-2

00-229110-002

2291102

**390968**

Vanne de sécurité 1/2" 2bar

00-229621-00001  
229621100229621001  
229621-1

00-229621-001

**392589**Vanne sécurité de pression  
avec raccord cannèle pour tuyau Ø 14,5 mm;  
avec virole 1"01244435001  
01-244435-1

01-244435-001

012444351

**392588**Vanne sécurité de pression  
avec raccord cannèle pour tuyau Ø 14,5 mm;  
avec virole 1"01244435002  
01-244435-2

01-244435-002

012444352

**381391**Raccord 3/4" - 1" H=27,50 mm  
CH33

00603076000

00-603076-000

603076

## Ressort

**390344**

**Ressorts de compression Ø 40 mm**  
**L=98 mm**  
 fil Ø 3,8 mm

00227873006  
 227873-6

00-227873-006

2278736

**397922**

**Ressort à gaz 100N Ø 6x120 mm**  
 trou Ø 6 mm - Ltot=320 mm

00774756001  
 774756-1

00-774756-001

7747561

**376238**

**Ressort de élévation L=40 mm Ø 35 mm**  
 CX - FUX

00229277000

00-229277-000

229277

**322796**

**Ressort de élévation L=40 mm Ø 41 mm**  
 FTT - CX - FUX

00230072000

00-230072-000

230072

**317537**

**Ressort de élévation L=40 mm Ø 47 mm**  
 CX - FUX

00229732000

00-229732-000

229732

**400306**

**Ressort de élévation L=40 mm Ø 47,00 mm**

00-325467-000  
 325467

00325467001  
 3254671

00-325467-001  
 325467-1

**376236**

**Ressort de élévation L=40 mm Ø 48 mm**  
 cpl.  
 FTN

00774749005  
 774749-5

00-774749-005

7747495

**378607**

**Ressort de élévation L=40 mm Ø 47 mm**  
 cpl.  
 FTN

00774749004  
 774749-4

00-774749-004

7747494

**376235**

**Ressort de élévation L=40 mm Ø 48 mm**  
 cpl.  
 axe Ø 10,5 mm - FTN

00774749006  
 774749-6

00-774749-006

7747496

**376234**

**Ressort de élévation L=40 mm Ø 50 mm**  
 cpl.  
 FTN

00774749002  
 774749-2

00-774749-002

7747492

## Ressort

**376237**

Ressort de élévation L=40 mm Ø 50 mm  
cpl.  
axe Ø 10,5 mm - FTN

00774749003  
774749-3

00-774749-003

7747493

**397939**

Ressort de élévation L=40 mm Ø 50 mm  
cpl.  
axe Ø 10,5 mm - FTN

00774749007  
774749-7

00-774749-007

7747497

**376239**

Ressort de élévation L=55mm Ø 65,5  
mm cpl.  
FN/FTP/FTX - CN/CS/CP

01245278007  
01-245278-7

01-245278-007

012452787

**395073**

Ressort de élévation L=55 mm Ø 66 mm  
cpl.  
FN/FTP/FTX - CN/CS/CP

01245278006  
01-245278-6

01-245278-006

012452786

**395072**

Ressort de élévation L=55 mm Ø 70,0  
mm cpl.  
axe Ø 11 mm - FN/FTP/FTX

01245278008  
01-245278-8

01-245278-008

012452788

**395078**

Ressort de élévation L=55 mm cpl.

01245278010  
01-245278-10

01-245278-010

0124527810

**378644**

Ressort de élévation L=55 mm Ø 65 mm  
cpl.  
FN/FTP/FTX - CN/CS/CP

01245278005  
01-245278-5

01-245278-005

012452785

**395074**

Ressort de élévation L=55 mm cpl.  
FN/FTP/FTX - CN/CS/CP

01245278004  
01-245278-4

01-245278-004

012452784

**395076**

Ressort de élévation L=55 mm cpl.  
FN/FTP/FTX - CN/CS/CP

01245278002  
01-245278-2

01-245278-002

012452782

**395079**

Ressort de élévation L=55 mm cpl.  
FN/FTP/FTX

01245278001  
01-245278-1

01-245278-001

012452781

## Ressort

**397938**

Ressort de élévation L=40 mm cpl.  
FTN

00774749008  
774749-8

00-774749-008

7747498

**397940**

Ressort de élévation L=40 mm cpl.  
FTN

00774749001  
774749-1

00-774749-001

7747491

**395075**

Ressort de élévation L=55 mm cpl.  
FN/FTP/FTX - CN/CS/CP

01245278003  
01-245278-3

01-245278-003

012452783

**387390**

Ressort de traction Ø 11,5x57xLtot.97  
mm  
fil Ø 1,4 mm

00228289000

00-228289-000

228289

**387513**

Support ressort Ø 10x32/43x10 mm

00229413000

00-229413-000

229413

**395069**

Support ressort Ø 66x32 mm  
Ø int. 10/est. 54,5/66 mm H=32 mm

01245280001  
01-245280-1

01-245280-001

012452801

**383434**

Support ressort [KIT]  
dim. 10x30x50 mm; avec axe, rondelle en  
goupille

00-173481-000  
173481

00897920000  
897920

00-897920-000

**381425**

Axe ressort de élévation Ø 10x70 mm  
trous Ø 3,3 mm

00602839000

00-602839-000

602839

**397850**

Axe ressort de élévation Ø 10x76 mm

00774495001  
774495-1

00-774495-001

7744951

**395053**

Axe ressort de élévation Ø 10x84 mm

01245281001  
01-245281-1

01-245281-001

012452811



## Ressort

**392511****Support ressort**

01245062001 01-245062-001 012450621  
01-245062-1

**409974****Support ressort**  
dim. 35x50x70 mm

00885529001 00-885529-001 8855291  
885529-1

**397847****Guide ressort**  
dim. 53x15 mm

00774499001 00-774499-001 7744991  
774499-1

## Rails et Montures de grille

**376195****Glissiere de porte 870x8xh11,5 mm**

00-112378-00021 00302207004 00-302207-004  
11237821 112378-21 3022074  
302207-4

**399539****Glissiere de porte L=885 mm**

00325064001 00-325064-001 3250641  
325064-1

**409988****Guide bras de lavage 2 supérieur**  
dim. 760x102x27 mm

00885577003 00-885577-003 8855773  
885577-3

**582856****Guide gauche**  
dim. 20x110x150 mm; filetage M10

01-245921-001 01-245921-1

**582857****Guide droite**  
dim. 20x110x150 mm; filetage M10

01-245921-002 01-245921-2

## Photocellule

**369589**

**Barrage photoélectrique capteur 24-240V  
10-200mA**  
câble L = 6000 mm, bague de fixation de  
corps de sonde M18

00691927001  
691927-1

00-691927-001

6919271

**388462**

**Réflecteur photocellule Ø 29x6 mm [KIT]**  
vis M3 L=8 mm; rondelle Ø 3,7x19,7x0,8 mm

00887031002  
01537791001  
01-537791-1  
887031-200-887031-002  
01-537791-001  
01537791-100-887031-2  
015377911  
8870312**397232**

**Cellule photoelectrique VT18-204470**  
DC 10-230V; temperatura di lavoro  
-25°C.....+70°C; connettore M12;4-pin

00695674010  
695674-10

00-695674-010

69567410

**397226**

**Cellule photoelectrique M12 Ltot=43 mm**  
cable=5000 mm

00695675002  
695675-2

00-695675-002

6956752

**397227**

**Cellule photoelectrique**  
câble L=5 m

00695675001  
695675-1

00-695675-001

6956751

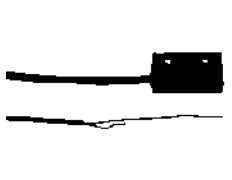
**400821**

**Récepteur photocellule**  
dim. 35x19.9x12/6 mm; câble L= 5000 mm

00301763006  
301763-6

00-301763-006

3017636

**400822**

**Récepteur photocellule**  
câble L=5000 mm

00301763005  
301763-5

00-301763-005

3017635

**408817**

**Récepteur photocellule**  
dim. 15x47x33 mm

00-887031-001  
887031100887178001  
887031-1

00-887178-001

## Platines

**317723**

**Platine électronique**  
LP201

E215022

**376379**

**Platine électronique**  
dim. 90x115 mm

00781142001  
781142-1

00-781142-001

7811421

**Platines**

**318202**



**Platine électronique FTN/CN LS**

00-695649-001	00695649002	00-695649-002
6956491	695649-1	6956492
695649-2		

**378605**



**Platine électronique (sans Eprom)**  
dim. 125x148 mm - CN

00897545004	00-897545-004	00897545204
00-897545-204	897545-204	8975454
897545-4		

**378625**



**Carte interface utilisateur 183x45 mm**

00-897540-001	00-897540-002	00897540201
00-897540-201	00897540202	00-897540-202
8975401	897540-1	8975402
897540-2	897540-201	897540-202

**323178**



**Eprom rev.4.02**

00897503005	00-897503-005	8975035
897503-5		

**582574**



**Eprom FW rev.0.7**

89750317	897503-17
----------	-----------

**325599**



**Eprom Rev. 11.5/3301**

00-897547-009	897547-9
---------------	----------

**390328**



**Câble chart**  
L=325 mm; puntale Ø 1,2x1,7 mm

00227073090	00-227073-090	22707390
227073-90		

**395399**



**Câble L=6000 mm**

01249758001	01-249758-001	012497581
01-249758-1		

**397229**



**Câble a/bouchons L=10 mt 80°C 300V**

00695674013	00-695674-013	00-695674-014
00-887031-003	00-887053-002	69567413
695674-13	69567414	695674-14
8870313	887031-3	8870532
887053-2		

**395272**



**Boîte électrique**  
dim. 165x95x50 mm

01245373001	01-245373-001	012453731
01-245373-1		

## Platines

**395243**

**Couverture pour boîte électrique**  
dim. 170x100xmm

01245374001  
01-245374-1

01-245374-001

012453741

**405831**

**Boîte électrique 90x220x60 mm**

00325023001  
325023-1

00-325023-001  
ML102837

3250231

**405799**

**Boîte électrique**  
dim. 220x90x53 mm

00325023002  
325023-2

00-325023-002  
ML102827

3250232

**408466**

**Connecteur 3 phases**

00785429016  
785429-16

00-785429-016

78542916

**408465**

**Connecteur 3 phases**

00785429019  
785429-19

00-785429-019

78542919

## Sondes

**376064**

**Clip de fixation sonde de température**  
dim. 24,5x35x5 mm

00-324157-000  
324157

00775489001  
7754891

00-775489-001  
775489-1

**398058**

**Sonde de température NTC**  
bulbe Ø 4,7x35,5 mm; câble L=250 mm

00775612002  
775612-2

00-775612-002

7756122

**376388**

**Sonde de température NTC**  
bulbe Ø 5x30 mm, câble L=265 mm

00-738455-000  
738455

00775612001  
7756121

00-775612-001  
775612-1

**376392**

**Sonde de température PTC**  
bulbe Ø 4,8x30 mm; câble L=3540 mm

00-229512-002  
2295122

00378584000  
229512-2

00-378584-000  
378584

## Sondes

**408413****Sonde de température [KIT]**

bulbe Ø 5,20x42 mm; câble L=2000 mm; avec  
pour bulbe Ø 6x210 mm - M21

00785292001	00-785292-001	00-846979-001
00-846979-002	00-846979-003	01533911001
01-533911-001	015339111	01-533911-1
7852921	785292-1	8469791
846979-1	8469792	846979-2
8469793	846979-3	

**398057**

**Sonde de température Ø 4,7x28 mm**  
L=3500mm

00775612003	00-775612-003	7756123
775612-3		

## Membranes

**459578**

**Membrane adhésive 234x134 mm**  
FTN / FTP

01-245674-001	12456741	1-245674-1
---------------	----------	------------

**394280**

**Membrane adhésive 187x45 mm**  
FTN / FTP / CS / CN / CP

01291845001	01-291845-001	012918451
01-291845-1		

**409120**

**Membrane adhésive 243x41 mm**  
CNR / CNA

00895770001	00-895770-001	8957701
895770-1		

## Filtres déshydrateur

**386970**

**Filtre déshydrateur Ø 76,5x245 mm**  
Ø IN 10 mm - OUT 10 mm; -40°C/+70°C

00323443000	00-323443-000	323443
-------------	---------------	--------

## O-ring



<b>376247</b>	1,50x6,00 mm	VITON	<b>276903-55</b>	<b>435178</b>	3,53x20,22 mm	VITON	<b>06750-72</b>
<b>373031</b>	1,78x5,28 mm	EPDM	<b>E456009</b>	<b>416272</b>	3,53x23,40 mm	SILICONE	<b>67500-11</b>
<b>337127</b>	1,78x9,25 mm	NBR	<b>E456019</b>	<b>438162</b>	3,53x28,17 mm	VITON	<b>67500-12</b>
<b>456112</b>	1,78x28,30 mm	EPDM	<b>E927094</b>	<b>373114</b>	3,53x47,53 mm	EPDM	<b>276903-21</b>
<b>376250</b>	2,00x24,00 mm	VITON	<b>276903-50</b>	<b>456115</b>	3,53x50,80 mm	EPDM	<b>E927097</b>
<b>438736</b>	2,62x15,54 mm	NBR	<b>609009</b>	<b>400902</b>	5,34x37,47 mm	VITON	<b>303117-1</b>
<b>376254</b>	3,00x25,00 mm	VITON	<b>276903-56</b>	<b>438465</b>	5,34x37,47 mm	EPDM	<b>67500-150</b>
<b>434029</b>	3,00x28,00 mm	EPDM	<b>276903-9</b>	<b>612335</b>	5,34x43,82 mm (3 pcs)	VITON	<b>233982-6</b>
<b>376256</b>	3,00x83,00 mm	EPDM	<b>775465-11</b>	<b>435303</b>	5,34x46,99 mm	NBR	<b>6750081</b>
<b>392404</b>	3,00x143,00 mm		<b>01-240272-001</b>	<b>376261</b>	5,34x47,00 mm	VITON	<b>01-240135-011</b>
<b>379455</b>	3,50x34,00 mm	EPDM	<b>139321-192</b>	<b>435067</b>	5,34x56,52 mm	NBR	<b>67500-118</b>
				<b>453928</b>	5,34x136,50 mm	EPDM	<b>E456076</b>

## Joints plats

391769



Joint en fibre Ø 18x2 mm

00168611022      00-168611-022      16861122  
168611-22

391746



Joint en fibre Ø 17x24x2 mm

00168611009      00-168611-009      1686119  
168611-9

400983



Joint en fibre Ø 20x30x2 mm

00302574002      00-302574-002      3025742  
302574-2

391765



Joint plate Ø 21x30x2mm

00168611003      00-168611-003      1686113  
168611-3

**Joints plats**

**390428**



Joint plate Ø 21x30x2 mm

00172986003      00-172986-003      1729863  
172986-3

---

**376175**



Joint plate Ø 25,5x34x2,5 mm pour chambre air

00775305001      00-775305-001      7753051  
775305-1

---

**390378**



Joint plate Ø 44x62x0,9 mm

00172986015      00-172986-015      17298615  
172986-15

---

**387458**



Joint Ø 210x260x2,3 mm  
trous Ø 13 mm

00229586000      00-229586-000      229586

---



info@professionalspares.com - [www.professionalspares.com](http://www.professionalspares.com)  
Via Malignani, 7 - 33083 Villotta di Chions (PN) - Italy  
Tel. +39 0434 639992 - Fax +39 0434 630217